

# **HIKOKI**

---

## **EC36DA**

---

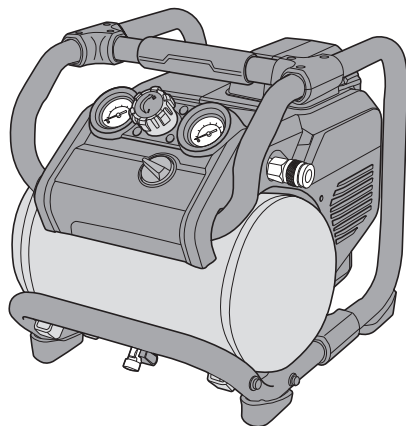

Handling instructions

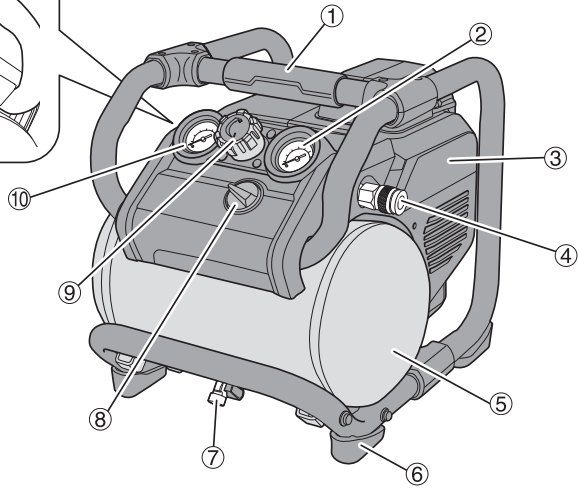
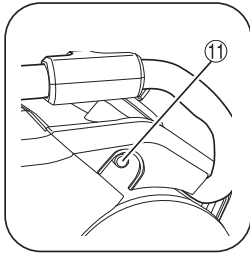
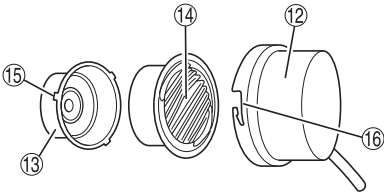
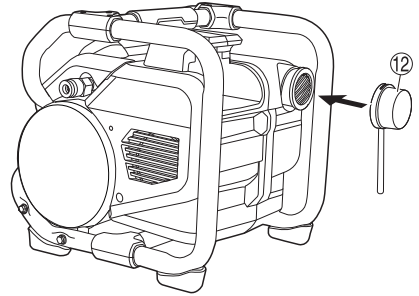
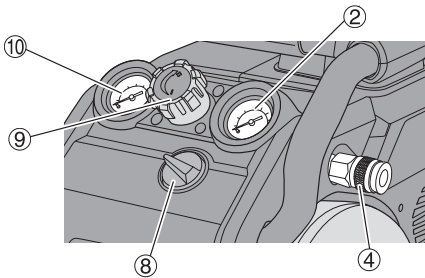
**1****2****3****4**

5

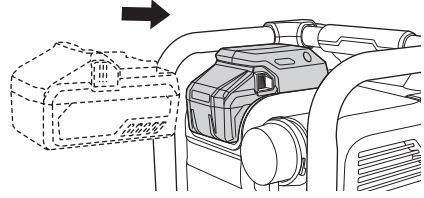
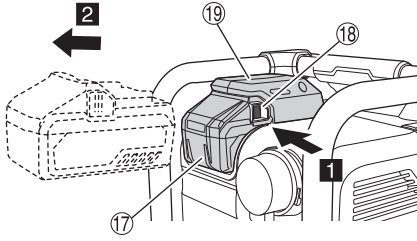

6

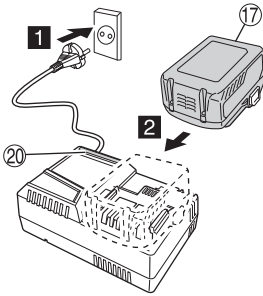

7

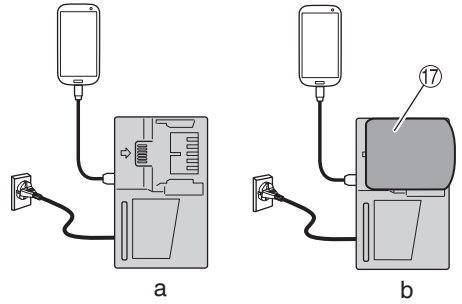

8

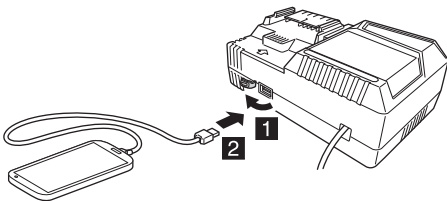

9

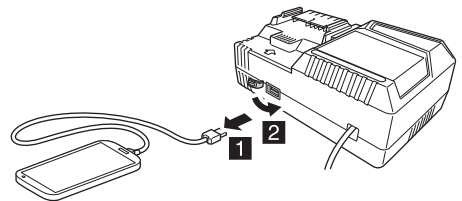

10

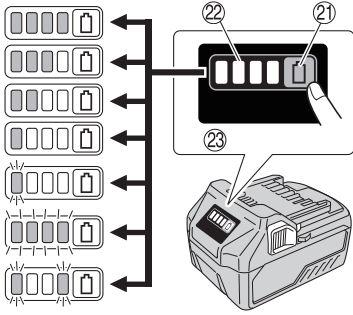

11

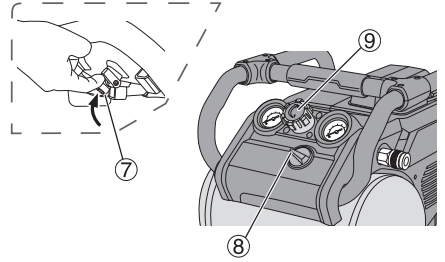

12

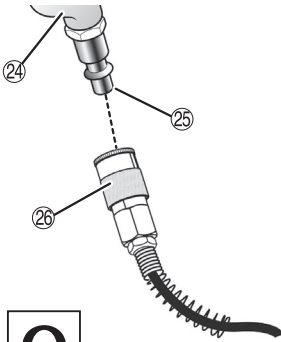

13

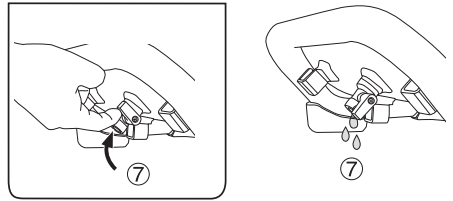

## GENERAL POWER TOOL SAFETY WARNINGS

### WARNING

Read all safety warnings, instructions, illustrations and specifications provided with this power tool.

Failure to follow all instructions listed below may result in electric shock, fire and/or serious injury.

Save all warnings and instructions for future reference.

The term "power tool" in the warnings refers to your mains-operated (corded) power tool or battery-operated (cordless) power tool.

#### 1) Work area safety

- a) **Keep work area clean and well lit.**  
*Cluttered or dark areas invite accidents.*
- b) **Do not operate power tools in explosive atmospheres, such as in the presence of flammable liquids, gases or dust.**  
*Power tools create sparks which may ignite the dust or fumes.*
- c) **Keep children and bystanders away while operating a power tool.**  
*Distractions can cause you to lose control.*

#### 2) Electrical safety

- a) **Power tool plugs must match the outlet. Never modify the plug in any way. Do not use any adapter plugs with earthed (grounded) power tools.**  
*Unmodified plugs and matching outlets will reduce risk of electric shock.*
- b) **Avoid body contact with earthed or grounded surfaces, such as pipes, radiators, ranges and refrigerators.**  
*There is an increased risk of electric shock if your body is earthed or grounded.*
- c) **Do not expose power tools to rain or wet conditions.**  
*Water entering a power tool will increase the risk of electric shock.*
- d) **Do not abuse the cord. Never use the cord for carrying, pulling or unplugging the power tool. Keep cord away from heat, oil, sharp edges or moving parts.**  
*Damaged or entangled cords increase the risk of electric shock.*
- e) **When operating a power tool outdoors, use an extension cord suitable for outdoor use.**  
*Use of a cord suitable for outdoor use reduces the risk of electric shock.*
- f) **If operating a power tool in a damp location is unavoidable, use a residual current device (RCD) protected supply.**  
*Use of an RCD reduces the risk of electric shock.*

#### 3) Personal safety

- a) **Stay alert, watch what you are doing and use common sense when operating a power tool. Do not use a power tool while you are tired or under the influence of drugs, alcohol or medication.**  
*A moment of inattention while operating power tools may result in serious personal injury.*
- b) **Use personal protective equipment. Always wear eye protection.**  
*Protective equipment such as a dust mask, non-skid safety shoes, hard hat or hearing protection used for appropriate conditions will reduce personal injuries.*

- c) **Prevent unintentional starting. Ensure the switch is in the off-position before connecting to power source and/or battery pack, picking up or carrying the tool.**

*Carrying power tools with your finger on the switch or energising power tools that have the switch on invites accidents.*

- d) **Remove any adjusting key or wrench before turning the power tool on.**

*A wrench or a key left attached to a rotating part of the power tool may result in personal injury.*

- e) **Do not overreach. Keep proper footing and balance at all times.**

*This enables better control of the power tool in unexpected situations.*

- f) **Dress properly. Do not wear loose clothing or jewellery. Keep your hair and clothing away from moving parts.**

*Loose clothes, jewellery or long hair can be caught in moving parts.*

- g) **If devices are provided for the connection of dust extraction and collection facilities, ensure these are connected and properly used.**

*Use of dust collection can reduce dust-related hazards.*

- h) **Do not let familiarity gained from frequent use of tools allow you to become complacent and ignore tool safety principles.**

*A careless action can cause severe injury within a fraction of a second.*

#### 4) Power tool use and care

- a) **Do not force the power tool. Use the correct power tool for your application.**

*The correct power tool will do the job better and safer at the rate for which it was designed.*

- b) **Do not use the power tool if the switch does not turn it on and off.**

*Any power tool that cannot be controlled with the switch is dangerous and must be repaired.*

- c) **Disconnect the plug from the power source and/or remove the battery pack, if detachable, from the power tool before making any adjustments, changing accessories, or storing power tools.**

*Such preventive safety measures reduce the risk of starting the power tool accidentally.*

- d) **Store idle power tools out of the reach of children and do not allow persons unfamiliar with the power tool or these instructions to operate the power tool.**

*Power tools are dangerous in the hands of untrained users.*

- e) **Maintain power tools and accessories. Check for misalignment or binding of moving parts, breakage of parts and any other condition that may affect the power tool's operation. If damaged, have the power tool repaired before use.**

*Many accidents are caused by poorly maintained power tools.*

- f) **Keep cutting tools sharp and clean.**

*Properly maintained cutting tools with sharp cutting edges are less likely to bind and are easier to control.*

- g) **Use the power tool, accessories and tool bits etc. in accordance with these instructions, taking into account the working conditions and the work to be performed.**

*Use of the power tool for operations different from those intended could result in a hazardous situation.*

## CORDLESS AIR COMPRESSOR SAFETY WARNINGS

- h) **Keep handles and grasping surfaces dry, clean and free from oil and grease.**  
*Slippery handles and grasping surfaces do not allow for safe handling and control of the tool in unexpected situations.*
- 5) **Battery tool use and care**
- a) **Recharge only with the charger specified by the manufacturer.**  
*A charger that is suitable for one type of battery pack may create a risk of fire when used with another battery pack.*
- b) **Use power tools only with specifically designated battery packs.**  
*Use of any other battery packs may create a risk of injury and fire.*
- c) **When battery pack is not in use, keep it away from other metal objects, like paper clips, coins, keys, nails, screws or other small metal objects, that can make a connection from one terminal to another.**  
*Shorting the battery terminals together may cause burns or a fire.*
- d) **Under abusive conditions, liquid may be ejected from the battery; avoid contact. If contact accidentally occurs, flush with water. If liquid contacts eyes, additionally seek medical help.**  
*Liquid ejected from the battery may cause irritation or burns.*
- e) **Do not use a battery pack or tool that is damaged or modified.**  
*Damaged or modified batteries may exhibit unpredictable behaviour resulting in fire, explosion or risk of injury.*
- f) **Do not expose a battery pack or tool to fire or excessive temperature.**  
*Exposure to fire or temperature above 130°C may cause explosion.*
- g) **Follow all charging instructions and do not charge the battery pack or tool outside the temperature range specified in the instructions.**  
*Charging improperly or at temperatures outside the specified range may damage the battery and increase the risk of fire.*
- 6) **Service**
- a) **Have your power tool serviced by a qualified repair person using only identical replacement parts.**  
*This will ensure that the safety of the power tool is maintained.*
- b) **Never service damaged battery packs.**  
*Service of battery packs should only be performed by the manufacturer or authorized service providers.*
- PRECAUTION**  
**Keep children and infirm persons away.**  
**When not in use, tools should be stored out of reach of children and infirm persons.**
1. **Don't expose compressor to rain. Never operate the compressor in damp or wet locations.**
2. **Disconnect the compressor.**  
Always disconnect the compressor from the battery and remove the compressed air from the tank before servicing, inspecting, maintaining, cleaning, replacing or checking any parts.
3. **Avoid unintentional starting.**  
Do not carry the compressor while it is connected to its battery or when the tank is filled with compressed air. Be sure the power switch in the "OFF" position before connecting the compressor to its battery.
4. **Store compressor properly.**  
When not in use, the compressor should be stored in indoor dry place. Keep out of reach of children. Lock-out the storage area.
5. **Consider work area environment.**  
Keep work area well lit and well ventilated. Operate the compressor in an open area at least 457 mm away from any wall or object that could restrict the flow of fresh air to the ventilation openings. Do not place rags or other objects on or near these openings. Risk of fire or explosion. Do not carry and operate the compressor or any other electrical device near the spray area. Do not use compressor in the presence of flammable liquids or gases.  
Never place objects against or on top of compressor. Compressor produces sparks during operation. Never use compressor in sites containing lacquer, paint, benzine, thinner, gasoline, gases, adhesive agents, and other materials which are combustible or explosive.  
Always operate the compressor in a stable and secure position to prevent accidental movement of the unit. Never operate the compressor on a roof or other elevated position. Never use on a ladder or unstable support. Use an additional air hose to reach high locations.  
This compressor contains some components parts that tend to produce arcs or sparks, and therefore, when located in a garage, it should be in a room or enclosure provided for this purpose, and should be 457 mm or more above the floor.
6. **Keep compressors as far from the spraying area as possible.**  
Risk of fire or explosion. Do not spray flammable liquid in a confined area. The spray area must be well ventilated. Do not smoke while spraying or spray where parks or a flame is present. Use spray gun hose at least 7.6 m long and keep the compressor/motor at least 6.1 m away from explosive vapours. Do not use this air compressor to spray chemicals. Your lungs can be damaged by inhaling toxic fumes.  
A respirator may be necessary in dusty environments or when spraying paint. Do not carry while painting.
7. **Maintain compressor with care.**  
Please conduct maintenance in accordance with page 15.
8. **Never use compressor for applications other than those specified.**  
Never use compressor for applications other than those specified in the Instruction Manual.  
Following all safety precautions in this manual and the manufacturer's instructions in the application manual. Never use compressed air for breathing or respiration.

9. **Handle compressor correctly.**  
Operate the compressor according to the instructions provided herein. Never allow the compressor to be operated by children, individuals unfamiliar with its operation or unauthorized personnel.
10. **Keep motor air vent clean.**  
The motor air vent must be kept clean so that air can freely flow at all times. Check for dust build-up frequently.
11. **Never use a compressor which is defective or operating abnormally.**  
If the compressor appears to be operating unusually, making strange noises or vibration, or otherwise appears defective, stop using it immediately and arrange for repairs by a HiKOKI authorized service center.
12. **Turn off the power switch when the compressor is not used.**  
When the compressor is not used, turn off the power switch, remove the battery and open the drain valve to discharge the compressed air from the tank.
13. **Never touch hot surface.**  
To reduce the risk of burns, do not touch the delivery pipe, check valve or pump.  
These areas can remain hot for at least 45 minutes after this compressor is shutdown.  
Allow compressor to cool prior to servicing.
14. **Drain tank.**  
Risk of bursting. Water will condense in the tank. If not drained, water will corrode and weaken the tank causing a risk of tank rupture.  
Drain tank daily or after 4 hours of use. To drain the tank, open valves slowly and tilt compressor to empty accumulated water.  
Keep face and the other body parts away from outlet of drain.  
Use the safety glasses with side shields when draining as debris can be kicked up into face.
15. **Do not stop compressor by removing the battery.**  
This could result in damage to the unit.  
Use the power switch.
16. **Make sure the compressor outlet pressure is set lower than the maximum operating pressure of the tool.**  
Too much air pressure causes a hazardous risk of bursting.  
Check the manufacturer's maximum pressure rating for air tools and accessories. The regulator outlet pressure must never exceed the maximum pressure rating.
17. **The safety valve must work properly.**  
Risk of bursting. Before starting the compressor, rotate the safety valve to make sure that the safety valve operates smoothly. If the safety valve does not work properly, over-pressurization may occur, causing tank rupture or an explosion. Do not use compressor if the safety valve is stuck or does not operate smoothly. Have defective safety valve replaced by a HiKOKI authorized service center.
18. **Protect material lines and air lines from damage or puncture.**  
Keep the hose and power cord away from sharp objects, chemical spills, oil, solvents, and wet floors.
19. **Check hoses for weak or worn condition before each use, making certain all connections are secure.**  
Do not use if a defect is found. Purchase a new hose or notify an authorized service center for examination or repair.
20. **Keep the exterior of the air compressor dry, clean, and free from oil and grease.**  
Always use a clean cloth when cleaning. Never use brake fluids, gasoline, petroleum-based products, or any strong solvents to clean the unit. Following this rule will reduce the risk of deterioration of the enclosure plastic.
21. **Make sure the hose is free of obstructions or snags.**  
Entangled or snarled hoses can cause loss of balance or footing and may become damaged.
22. **Never leave a compressor unattended with the air hose attached.**
23. **Do not operate this compressor if it does not contain a legible warning label.**
24. **Do not continue to use a compressor or hose that leaks air or does not function properly.**
25. **Always disconnect the air supply and battery before making adjustments, servicing a compressor, or when a compressor is not in use.**
26. **Do not attempt to pull or carry the air compressor by the hose.**
27. **Your tool may require more air consumption than this air compressor is capable of providing.**
28. **Inspect compressor hoses periodically and, if damaged, have repaired at your nearest authorized service center.**  
Following this rule will reduce the risk of injury.
29. **Because the cordless air compressor operates by battery power, be aware of the fact that it can begin to operate at any time.**
30. **Check damaged parts and air leak.**  
Before further use of the compressor, a guard or other part is damaged should be carefully checked to determine that it will operate properly and perform its intended function. Check for alignment of moving parts, binding of moving parts, breakage of parts, mounting, air leak, and any other conditions that may affect its operation.  
A guard or other part that is damaged should be properly repaired or replaced by a HiKOKI authorized service center.  
Have defective power switches replaced by a HiKOKI authorized service center.  
Do not use compressor if power switch does not turn it on and off.
31. **Keep all screws, bolts and guards tightly in place.**  
Keep all screws, bolts, and guards tightly mounted. Check their conditions periodically.
32. **Do not direct air stream at body.**  
Risk of injury. Do not direct air stream at persons or animals.
33. **Release the pressure within the system slowly.**  
Dust and debris may be harmful.
34. **Always charge the battery at a temperature of 0°C–40°C.** A temperature of less than 0°C will result in over charging which is dangerous. The battery cannot be charged at a temperature higher than 40°C.  
The most suitable temperature for charging is that of 20°C–25°C.
35. **Do not use the charger continuously.**  
When one charging is completed, leave the charger for about 15 minutes before the next charging of battery.
36. **Do not allow foreign matter to enter the hole for connecting the rechargeable battery.**
37. **Never disassemble the rechargeable battery and charger.**
38. **Never short-circuit the rechargeable battery.**  
Shortcircuiting the battery will cause a great electric current and overheat. It results in burn or damage to the battery.

39. Do not dispose of the battery in fire. If the battery is burnt, it may explode.
  40. Bring the battery to the shop from which it was purchased as soon as the post-charging battery life becomes too short for practical use. Do not dispose of the exhausted battery.
  41. Do not insert object into the air ventilation slots of the charger. Inserting metal objects or inflammables into the charger air ventilation slots will result in electrical shock hazard or damaged charger.
  42. Make sure that the battery is installed firmly. If it is at all loose it could come off and cause an accident.
  43. Never touch moving parts.  
Never place your hands, fingers or other body parts near the compressor's moving parts.
  44. Do not use the product if the compressor or the battery terminals (battery mount) are deformed.  
Installing the battery could cause a short circuit that could result in smoke emission or ignition.
  45. Keep the compressor's terminals (battery mount) free of swarf and dust.
    - Prior to use, make sure that swarf and dust have not collected in the area of the terminals.
    - During use, try to avoid swarf or dust on the compressor from falling on the battery.
    - When suspending operation or after use, do not leave the compressor in an area where it may be exposed to falling swarf or dust.  
Doing so could cause a short circuit that could result in smoke emission or ignition.
  46. Always use the compressor and battery at temperatures between 0°C and 40°C.
3. Do not use an apparently damaged or deformed battery.
  4. Do not use the battery in reverse polarity.
  5. Do not connect directly to an electrical outlets or car cigarette lighter sockets.
  6. Do not use the battery for a purpose other than those specified.
  7. If the battery charging fails to complete even when a specified recharging time has elapsed, immediately stop further recharging.
  8. Do not put or subject the battery to high temperatures or high pressure such as into a microwave oven, dryer, or high pressure container.
  9. Keep away from fire immediately when leakage or foul odor are detected.
  10. Do not use in a location where strong static electricity generates.
  11. If there is battery leakage, foul odor, heat generated, discolored or deformed, or in any way appears abnormal during use, recharging or storage, immediately remove it from the equipment or battery charger, and stop use.
  12. Do not immerse the battery or allow any fluids to flow inside. Conductive liquid ingress, such as water, can cause damage resulting in fire or explosion. Store your battery in a cool, dry place, away from combustible and flammable items. Corrosive gas atmospheres must be avoided.

#### CAUTION

1. If liquid leaking from the battery gets into your eyes, do not rub your eyes and wash them well with fresh clean water such as tap water and contact a doctor immediately.  
If left untreated, the liquid may cause eye-problems.
2. If liquid leaks onto your skin or clothes, wash well with clean water such as tap water immediately.  
There is a possibility that this can cause skin irritation.
3. If you find rust, foul odor, overheating, discolor, deformation, and/or other irregularities when using the battery for the first time, do not use and return it to your supplier or vendor.

#### WARNING

If a conductive foreign matter enters in the terminal of lithium ion battery, the battery may be shorted, causing fire. When storing the lithium ion battery, obey surely the rules of following contents.

- Do not place conductive debris, nail and wires such as iron wire and copper wire in the storage case.
- To prevent shorting from occurring, load the battery in the tool or insert securely the battery cover for storing until the ventilator is not seen.

### CAUTION ON LITHIUM-ION BATTERY

To extend the lifetime, the lithium-ion battery equips with the protection function to stop the output.

In the cases of 1 to 3 described below, when using this product, even if you are pulling the switch, the motor may stop. This is not the trouble but the result of protection function.

1. When the battery power remaining runs out, the motor stops.  
In such a case, charge it up immediately.
2. If the tool is overloaded, the motor may stop. In this case, release the switch of tool and eliminate causes of overloading. After that, you can use it again.
3. If the battery is overheated under overload work, the battery power may stop.  
In this case, stop using the battery and let the battery cool. After that, you can use it again.

Furthermore, please heed the following warning and caution.

#### WARNING

In order to prevent any battery leakage, heat generation, smoke emission, explosion and ignition beforehand, please be sure to heed the following precautions.

1. Make sure that swarf and dust do not collect on the battery.
  - During work make sure that swarf and dust do not fall on the battery.
  - Make sure that any swarf and dust falling on the power tool during work do not collect on the battery.
  - Do not store an unused battery in a location exposed to swarf and dust.
  - Before storing a battery, remove any swarf and dust that may adhere to it and do not store it together with metal parts (screws, nails, etc.).
2. Do not pierce battery with a sharp object such as a nail, strike with a hammer, step on, throw or subject the battery to severe physical shock.



## REGARDING LITHIUM-ION BATTERY TRANSPORTATION

When transporting a lithium-ion battery, please observe the following precautions.

### WARNING

Notify the transporting company that a package contains a lithium-ion battery, inform the company of its power output and follow the instructions of the transportation company when arranging transport.

- Lithium-ion batteries that exceed a power output of 100 Wh are considered to be in the freight classification of Dangerous Goods and will require special application procedures.
- For transportation abroad, you must comply with international law and the rules and regulations of the destination country.
- If the BSL36B18 is installed in the power tool, the power output will exceed 100 Wh and the unit will be classified as Dangerous Goods for freight classification.

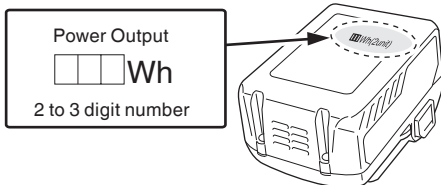

## USB DEVICE CONNECTION PRECAUTIONS (UC18YSL3)

When an unexpected problem occurs, the data in a USB device connected to this product may be corrupted or lost. Always make sure to back up any data contained in the USB device prior to use with this product.

Please be aware that our company accepts absolutely no responsibility for any data stored in a USB device that is corrupted or lost, nor for any damage that may occur to a connected device.

### WARNING

- Prior to use, check the connecting USB cable for any defect or damage.  
Using a defective or damaged USB cable can cause smoke emission or ignition.
- When the product is not being used, cover the USB port with the rubber cover.  
Buildup of dust etc. in the USB port can cause smoke emission or ignition.

### NOTE

- There may be an occasional pause during USB recharging.
- When a USB device is not being charged, remove the USB device from the charger.  
Failure to do so may not only reduce the battery life of a USB device, but may also result in unexpected accidents.
- It may not be possible to charge some USB devices, depending on the type of device.

<USB charging>

- Charging a USB device from an electrical outlet (Fig. 7-a)
- Charging a USB device and battery from an electrical outlet (Fig. 7-b)
- How to recharge USB device (Fig. 8)
- When charging of USB device is completed (Fig. 9)

## NAMES OF PARTS (Fig. 1–Fig. 13)











①	Handle
②	Regulator pressure gauge
③	Electric motor & air compressor pump
④	Quick coupler
⑤	Tank
⑥	Rubber foot
⑦	Drain valve
⑧	Power switch (Pressure switch inside)
⑨	Pressure regulator knob
⑩	Tank pressure gauge
⑪	Safety valve
⑫	Intake filter
⑬	Intake filter body
⑭	Filter element
⑮	Protrusions (× 3)
⑯	Grooves (× 3)
⑰	Battery
⑱	Latch
⑲	Head cover
⑳	Charger indicator lamp
㉑	Battery level indicator switch
㉒	Battery level indicator lamp
㉓	Display panel
㉔	Pneumatic tool (not included)
㉕	Male quick-connect plug
㉖	Air hose with quick coupler fitting (not included)

## SYMBOLS







### WARNING

The following show symbols used for the machine. Be sure that you understand their meaning before use.

	EC36DA: Cordless Air Compressor
	To reduce the risk of injury, user must read instruction manual.
	Always wear eye protection.
	Direct current

V	Rated voltage
	Disconnect the battery
I	Switching ON
O	Switching OFF
	Warning
	Electric shock hazard.
	Hearing protection must be worn.
	Guaranteed sound power level
	Do not open the cock before the air hose is attached.
	Risk of high temperature.
	Warning of compressor unit may start without warning
	Do not expose to rain. Store indoors.
	Risk of Bursting Do not adjust the regulator to result in output pressure greater than the marked maximum pressure of the attachment. Do not use at a pressure greater than the rated maximum pressure of this compressor.

#### Battery

	Lights ; The battery remaining power is over 75%
	Lights ; The battery remaining power is 50%–75%.
	Lights ; The battery remaining power is 25%–50%.
	Lights ; The battery remaining power is less than 25%
	Blinks ; The battery remaining power is nearly empty. Recharge the battery soonest possible.
	Blinks ; Output suspended due to high temperature. Remove the battery from the tool and allow it to fully cool down.
	Blinks ; Output suspended due to failure or malfunction. The problem may be the battery so please contact your dealer.

## STANDARD ACCESSORIES

In addition to the main unit (1 unit), the package contains the accessories listed on page 19.

Standard accessories are subject to change without notice.

## SPECIFICATIONS

### 1. Cordless Air Compressor

Model	EC36DA	
Motor	Brushless DC	
Voltage	36 V	
Tank Capacity	7.3 ltr (1.9 gal.)	
Maximum Pressure	9.3 bar (135 PSI)	
Free Air Delivery	at 2.8 bar (40 PSI)	65.1 ltr/min (2.3 CFM)
	at 6.2 bar (90 PSI)	45.3 ltr/min (1.6 CFM)
Lubrication	Oil-less	
Battery available for this tool*	Multi volt battery	
Weight	14.3 kg (31.5 lbs) (BSL36B18 attached)	

\* Existing batteries (BSL3660/3626/3620, BSL18xx and BSL14xx series, etc.) cannot be used with this tool.

### NOTE

Due to HiKOKI's continuing program of research and development, the specifications herein are subject to change without prior notice.

### 2. Battery Charger (sold separately)

Model	UC18YSL3
Input power source	Single phase: AC 120 V 60 Hz
Charging time (At a temperature of 20°C)	BSL36B18 : Approx.52 min
Charging voltage	DC 14.4–18 V
Charging current	DC 8.0 A
Weight	0.6 kg

### NOTE

The charging time may vary according to temperature and power source voltage.

### 3. Battery (sold separately)

Model	BSL36A18	BSL36B18
Voltage	36 V / 18 V (Automatic Switching*)	
Battery capacity	2.5 Ah / 5.0 Ah	4.0 Ah / 8.0 Ah
	(Automatic Switching*)	
Available cordless products**	Multi volt series, 18 V product	
Available charger	Sliding charger for lithium ion batteries	

\* The tool itself will automatically switch over.

\*\* Please see our general catalogue for details.

## KNOW YOUR AIR COMPRESSOR

Before attempting to use this product, familiarize yourself with all operating features and safety rules. (Fig. 1)

### Oil-free brushless motor

Your air compressor features permanently lubricated bearings.

### Power switch (pressure switch inside)

This switch is used to start or stop the air compressor. Moving the power switch to the (ON) position will provide automatic power to the pressure switch which will allow the motor to start when the tank pressure is below the factory set cut-in pressure. When in the (ON) position, the pressure switch stops the motor when the tank pressure reaches the factory set cut-out pressure. Moving the power switch to the (OFF) position will remove power from the motor and stop the air compressor.

### Electric motor & air compressor pump

The motor is used to power the pump. The electric motor has a thermal overload protector. If the motor overheats for any reason, the thermal overload will cut off power, thus preventing the motor from being damaged. Wait until the motor is cool. Motor resets automatically.

Air compressor pump: to compress air, the piston moves up and down in the cylinder. On the down stroke, air is drawn in through the air intake valve while the exhaust valve remains closed. On the upstroke, air is compressed, the intake valve closes and compressed air is forced out through the exhaust valve, into the discharge line, through the check valve and into the tank.

### Safety valve

This valve is designed to prevent system failures by relieving pressure from the system when the compressed air reaches a predetermined level. The valve is preset by the manufacturer and must not be modified in any way.

### Drain valve

The drain valve is used to remove moisture from the tank.

### Tank pressure gauge

The tank pressure gauge indicates the pressure of the air in the tank.

### Regulator pressure gauge

The current line pressure is displayed on the regulator pressure gauge. This pressure can be adjusted by rotating the pressure regulator knob.

### Pressure regulator knob

Use the pressure regulator knob to adjust the amount of air being delivered through the hose.

The air pressure coming from the tank is controlled by the regulator knob. Turn the pressure regulator knob clockwise to increase discharge pressure and counterclockwise to decrease discharge pressure. Follow tool operating instructions for recommended pressure range.

### Tank

The tank is used to store the compressed air.

### Quick coupler

The outlet is used to connect the 1/4 in. NPT air hose.

### Overload protector

This air compressor is equipped with a thermal overload device which will turn the air compressor off automatically, if the air compressor becomes overheated. If the motor turns OFF repeatedly, check for the following possible causes first: The battery is depleted. Lack of proper ventilation or outside air or room temperature too high.

### To reset the air compressor:

- (1) Turn the air compressor off.
- (2) Remove the battery and allow the air compressor to cool for 30 minutes.
- (3) Install the battery in the air compressor.
- (4) Turn the air compressor on.

## ASSEMBLY

### 1. Unpacking

This product requires assembly.

- Carefully remove the compressor and any accessories from the box. Make sure that all items listed in the packing list are included.
- Inspect the compressor carefully to make sure no breakage or damage occurred during shipping.
- Do not discard the packing material until you have carefully inspected and satisfactorily operated the compressor.

### 2. Packing list

- Air Compressor
- Instructions Manual
- Intake Filter

### WARNING

- If any parts are missing do not operate the compressor until the missing parts are replaced. Failure to do so could result in possible serious personal injury.
- Do not attempt to modify this compressor or create accessories not recommended for use with this compressor. Any such alteration or modification is misuse and could result in a hazardous condition leading to possible serious personal injury.

### 3. Attaching the intake filter

#### CAUTION

Do not operate without the intake filter.

- Turn off the power of the air compressor, and remove the battery.
- Turn the intake filter counter-clockwise until it stops and then remove the intake filter cap and filter element. (Fig. 2)
- Firmly screw in the intake filter body.
- After inserting the filter element, match the grooves of the intake filter cap with the three protrusions on the intake filter body so that the hose points downward. Then, turn the intake filter cap clockwise until it stops.
- Check to see if the intake filter cap is loose. If the filter is loose, remove and reinstall the filter. (Fig. 3)

### 4. Attaching hose (sold separately)

- Insert the hose into the quick coupler already installed on the compressor. (Fig. 4)

### WARNING

Do not attach any tools to the open end of the hose until start-up has been completed.

- Firmly grasp the open end of the hose; hold facing away from yourself and others.

## REMOVAL AND INSTALLATION METHOD OF BATTERY









- How to install the battery.  
Align the battery with the groove in head cover and slip it into place.  
Always insert it all the way until it locks in place with a little click. If not, it may accidentally fall out of the tool, causing injury to you or someone around you. (Fig. 5)
- How to remove the battery.  
Withdraw battery from the head cover while pressing the latch (2 pcs) of the battery. (Fig. 5)

## CHARGING

Before using the power tool, charge the battery as follows.

1. **Connect the charger's power cord to the receptacle.**  
When connecting the plug of the charger to a receptacle, the charge indicator lamp will blink in red (At 1-second intervals).
  2. **Insert the battery into the charger.**  
Firmly insert the battery into the charger as shown in Fig. 6 (on page 3).
  3. **Charging**  
When inserting a battery in the charger, the charge indicator lamp will blink in blue.  
When the battery becomes fully recharged, the charge indicator lamp will light up in green. (See Table 1)
- (1) Charge indicator lamp indication  
The indications of the charge indicator lamp will be as shown in Table 1, according to the condition of the charger or the rechargeable battery.

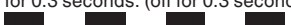
Table 1

Indications of the charge indicator lamp				
Charge indicator lamp (RED / BLUE / GREEN / PURPLE)	Before charging	Blinks (RED)	Lights for 0.5 seconds. Does not light for 0.5 seconds. (off for 0.5 seconds) 	Plugged into power source
	While charging	Blinks (BLUE)	Lights for 0.5 seconds. Does not light for 1 second. (off for 1 second) 	Battery capacity at less than 50%
		Blinks (BLUE)	Lights for 1 second. Does not light for 0.5 seconds. (off for 0.5 seconds) 	Battery capacity at less than 80%
		Lights (BLUE)	Lights continuously 	Battery capacity at more than 80%
	Charging complete	Lights (GREEN)	Lights continuously (Continuous buzzer sound: about 6 seconds) 	
	Overheat standby	Blinks (RED)	Lights for 0.3 seconds. Does not light for 0.3 seconds. (off for 0.3 seconds) 	
	Charging impossible	Flickers (PURPLE)	Lights for 0.1 seconds. Does not light for 0.1 seconds. (off for 0.1 seconds)  (Intermittent buzzer sound: about 2 seconds)	Malfunction in the battery or the charger

- (2) Regarding the temperatures and charging time of the rechargeable battery  
The temperatures and charging time will become as shown in **Table 2**.

**Table 2**

Charger		UC18YSL3					
Battery	Type of battery	Li-ion					
	Temperatures at which the battery can be recharged	0°C–50°C					
	Charging voltage	V	14.4		18		
	Charging time, approx. (At 20°C)	min	BSL14xx series		BSL18xx series		Multi volt series
			(4 cells)	(8 cells)	(5 cells)	(10 cells)	(10 cells)
		BSL1415S : 15 BSL1415 : 15 BSL1415X : 15 BSL1420 : 20 BSL1425 : 25 BSL1430C : 30	BSL1430 : 20 BSL1440 : 26 BSL1450 : 32 BSL1460 : 38	BSL1815S : 15 BSL1815 : 15 BSL1815X : 15 BSL1820 : 20 BSL1825 : 25 BSL1830C : 30 BSL1850C : 32	BSL1830 : 20 BSL1840 : 26 BSL1850 : 32 BSL1860 : 38	BSL36A18 : 32 BSL36B18 : 52	
USB	Charging voltage	V	5				
	Charging current	A	2				

**NOTE**

The recharging time may vary according to the ambient temperature and power source voltage.

4. **Disconnect the charger's power cord from the receptacle.**

5. **Hold the charger firmly and pull out the battery.**

**NOTE**

Be sure to pull out the battery from the charger after use, and then keep it.

**Regarding electric discharge in case of new batteries, etc.**

As the internal chemical substance of new batteries and batteries that have not been used for an extended period is not activated, the electric discharge might be low when using them the first and second time. This is a temporary phenomenon, and normal time required for recharging will be restored by recharging the batteries 2–3 times.

**How to make the batteries perform longer.**

- (1) Recharge the batteries before they become completely exhausted.

When you feel that the power of the tool becomes weaker, stop using the tool and recharge its battery. If you continue to use the tool and exhaust the electric current, the battery may be damaged and its life will become shorter.

- (2) Avoid recharging at high temperatures.

A rechargeable battery will be hot immediately after use. If such a battery is recharged immediately after use, its internal chemical substance will deteriorate, and the battery life will be shortened. Leave the battery and recharge it after it has cooled for a while.

**CAUTION**

- If the battery is charged while it is heated because it has been left for a long time in a location subject to direct sunlight or because the battery has just been used, the charge indicator lamp of the charger lights for 0.3 seconds, does not light for 0.3 seconds (off for 0.3 seconds). In such a case, first let the battery cool, then start charging.
- When the charge indicator lamp flickers (at 0.2-second intervals), check for and take out any foreign objects in the charger's battery connector. If there are no foreign objects, it is probable that the battery or charger is malfunctioning. Take it to your authorized Service Center.
- Since the built-in micro computer takes about 3 seconds to confirm that the battery being charged with UC18YSL3 is taken out, wait for a minimum of 3 seconds before reinserting it to continue charging. If the battery is reinserted within 3 seconds, the battery may not be properly charged.

## ABOUT REMAINING BATTERY INDICATOR

You can check the battery's remaining capacity by pressing the remaining battery indicator switch to light the indicator lamp. (Fig. 10)

The indicator will shut off approximately 3 seconds after the remaining battery indicator switch is pressed.

It is best to use the remaining battery indicator as a guide since there are slight differences such as ambient temperature and the condition of the battery.

When the battery's remaining capacity is low, the motor may stop even if 1 light on the indicator lamp is lit up. This is not the trouble but the result of protection function. If this happens, recharge the battery as soon as possible.

### NOTE

- Remaining battery levels may vary between that shown on the battery and that of a product with its own battery level function.
- Do not give a strong shock to the display panel or break it. It may lead to a trouble.

## APPLICATIONS

Air compressors are utilized in a variety of air system applications.

Match hoses, connectors, air tools, and accessories to the capabilities of the air compressor.

You may use this compressor for purposes listed below:

- Operating air powered tools requiring less than 45.3 ltr/min @ 6.2 bar.
- Powering pneumatic nail guns, inflating tires, cleaning / blowing with pressurized air.

### WARNING

- Do not allow familiarity with compressor and tools to make you careless. Remember that a careless fraction of a second is sufficient to inflict serious injury.
- Always wear safety goggles or safety glasses with side shields when operating compressor. Failure to do so could result in objects being thrown into your eyes resulting in possible serious injury.

### CAUTION

Do not use in an environment that is dusty or otherwise contaminated. Using the air compressor in this type of environment may cause damage to the unit.

## CHECKING THE SAFETY VALVE

Before starting the compressor, rotate the safety valve to make sure that the safety valve operates smoothly. Do not use compressor if the safety valve is stuck or does not operate smoothly. Have defective safety valve replaced by a HiKOKI authorized service center.

### WARNING

- Drain tank to release air pressure before rotate the safety valve.
- Risk of bursting.  
If the safety valve does not work properly, over-pressurization may occur, causing tank rupture or an explosion.

## USING THE AIR COMPRESSOR

- Temperature

Operating temperatures are between 0°C and 40°C.

### CAUTION

Never operate in temperatures below 0°C or above 40°C.

### WARNING

Always ensure the power switch is in the **OFF (O)** position and the regulator pressure gauge reads zero before changing air tools or disconnecting the hose from the air outlet. Failure to do so could result in possible serious personal injury.

- Ensure the drain valve is closed. (Fig. 11)
- Ensure the power switch is in the **OFF (O)** position and the battery is removed.
- Ensure the pressure regulator knob is turned fully counterclockwise. (Fig. 11)
- If not already installed, attach the hose to the compressor.
- Connect the air powered tools to the air hose by inserting the male quick-connect plug to the quick-coupler at the end of the hose. (Fig. 12)
- Install the battery.
- Turn the power switch to the **ON (I)** position.
- Adjustment of outlet pressure

Pull the pressure regulator knob to allow the knob to rotate. Then, adjust the outlet pressure to the required level by turning the pressure regulator knob clockwise to increase the outlet pressure and counterclockwise to decrease it.

A regulator pressure gauge is provided to show when the required pressure is reached.

When adjusting the pressure, check and make sure that a tank pressure gauge for the tank has the pressure level that is higher than that of the pressure to be adjusted.

It is also imperative that you make adjustment by slowly starting up the pressure from the level that is lower than the pressure to be adjusted.

After adjusting the outlet pressure, push in the pressure regulator knob to lock the knob and use the tool.

### NOTE

Before connecting or disconnecting air tools, turn the regulator knob counterclockwise to stop the flow of air.

- Following all safety precautions in this manual and the manufacturer's instructions in the air tool manual, you may now use your air-powered tool.
- If using an inflation accessory with a quick-connect fitting, control the amount of air flow with the pressure regulator knob. Turning the knob fully counterclockwise will completely stop the flow of air.

### NOTE

Always use the minimum amount of pressure necessary for your application. Using a higher pressure than needed will drain air from the tank more rapidly and cause the unit to cycle on more frequently.

- When finished, always drain the tank and remove the battery. Never leave the unit plugged in and/or running unattended.

## WARNING

Check the air tool manual to ensure the correct air pressure regulator setting for optimum operation of your air tools. If you are using an air tool not originally included in the package contents list (not necessarily supplied with the air compressor model you have purchased), your tool may require more air consumption than this air compressor is designed to supply.

Always read your air tool owner's manual to match the correct air supply to your air tool to avoid damage to the tool or risk of personal injury.

## NOTE

When the compressor is new, it will require a "break-in" period to reach maximum performance. The typical break-in period is four discharge cycles of the battery using the BSL36B18 battery.

## DRAINING THE TANK

To help prevent tank corrosion and keep moisture out of the air used, the tank of the compressor should be drained daily.

### To drain the tank: (Fig. 13)

- Verify that the compressor is turned off.
- Holding the handle, tilt the compressor toward the drain valve so that it's set in a lower position.
- Open the drain valve by rotating it 1/4 turn counterclockwise.
- Keep the compressor tilted until all moisture has been removed.
- Drain moisture from tank into a suitable container.

## NOTE

Condensate is a polluting material and should be disposed of in compliance with local regulations.

- If drain valve is clogged, release all air pressure by pulling the safety valve. Remove and clean valve, then reinstall.

## WARNING

Remove the battery from the air compressor and release all air from the tank before servicing. Failure to depressurize tank before attempting to remove valve may cause serious personal injury.

- Close the drain valve by rotating it 1/4 turn clockwise.

## END OF OPERATION/STORAGE

- Turn the power switch to the **OFF** position.
- Remove the battery.
- Open the drain valve located at the lower part of the tank. (Fig. 13) Tank pressure should be below 10 psi when draining the tank.

## WARNING

Risk of bursting. When the tank gets corroded, there is a risk of breakdown. Water will condense in the tank. If not drained, water will corrode and weaken the tank causing a risk of tank rupture. Drain tank daily or after 4 hours of use. The drain contains moisture in the air, abrasion particles, rust, etc..

To drain tank open valve slowly and tilt compressor to empty accumulated water. Keep face and eyes away from drain cock.

- Air hose should be disconnected from compressor and hung open ends down to allow any moisture to drain.
- Compressor and hose should be stored in a cool, dry place.

## TRANSPORT

- Turn the power switch to the **OFF** position.
- Remove the battery.
- Disconnect the air hose and depressurize the tank.
- Transport the compressor by holding the handle.

## OPERATIONAL CAUTIONS

Resting the unit after continuous work

- (1) The power tool is equipped with a temperature protection circuit to protect the motor.

Continuous work may cause the temperature of the unit to rise, activating the temperature protection circuit and automatically stopping operation.

If this happens, allow the power tool to cool before resuming use.

- (2) After use for continuous work, rest the unit for 15 minutes or so when replacing the battery. The temperature of the motor, switch, etc., will rise if the work is started again immediately after battery replacement, eventually resulting in burnout.

## MAINTENANCE AND INSPECTION

### WARNING

- Be sure to turned off the switch and remove the battery before maintenance and inspection.
- When servicing, use only identical replacement parts. Use of any other parts may create a hazard or cause product damage.
- Always wear safety goggles or safety glasses with side shields during compressor operation or when blowing dust. If operation is dusty, also wear a dust mask.
- Always release all pressure, disconnect from power supply, and allow unit to cool to the touch before cleaning or making repairs on the air compressor.

#### 1. General maintenance

- Humidity in the air causes condensation to form in the tank. This condensation should be drained daily and/or every hour, using the instructions found in **Draining the Tank**.
- The safety valve automatically releases air if the air receiver pressure exceeds the preset maximum. Check the safety valve before each use following the instructions found in **Checking the Safety Valve**.
- Inspect the tank yearly for rust, pin holes, or other imperfections that could cause it to become unsafe.
- Avoid using solvents when cleaning plastic parts. Most plastics are susceptible to damage from various types of commercial solvents and may be damaged by their use. Use clean cloths to remove dirt, dust, oil, grease, etc.

### WARNING

Do not at any time let brake fluids, gasoline, petroleum-based products, penetrating oils, etc., come in contact with plastic parts.

Chemicals can damage, weaken or destroy plastic which may result in serious personal injury.

#### 2. Lubrication

All the bearings in this compressor are lubricated with a sufficient amount of high grade lubricant for the life of the unit under normal operating conditions. Therefore, no further lubrication of the bearings is required.

### 3. Cleaning the intake filter

#### WARNING

Never clean filter element with a flammable liquid or solvent.

Open the intake filter once a week and clean the inside of the intake filter and the filter element with compressed air. (Fig. 2)

#### NOTE

Replace the filter element when it becomes dirty.

### 4. Inspection of terminals (tool and battery)

Check to make sure that swarf and dust have not collected on the terminals.

On occasion check prior, during and after operation.

#### CAUTION

Remove any swarf or dust which may have collected on the terminals.

Failure to do so may result in malfunction.

### 5. Disposal of the exhausted battery

#### WARNING

Do not dispose of the exhausted battery. The battery must explode if it is incinerated. The battery is recyclable. At the end of its useful life, under various state and local laws, it may be illegal to dispose of this battery into the municipal waste stream. Check with your local solid waste officials for details in your area for recycling options or proper disposal.

### 6. Storage

Store the power tool and battery in a place in which the temperature is less than 40°C and out of reach of children.

#### NOTE

Storing lithium-ion batteries.

Make sure the lithium-ion batteries have been fully charged before storing them.

Prolonged storage (3 months or more) of batteries with a low charge may result in performance deterioration, significantly reducing battery usage time or rendering the batteries incapable of holding a charge.

However, significantly reduced battery usage time may be recovered by repeatedly charging and using the batteries two to five times.

If the battery usage time is extremely short despite repeated charging and use, consider the batteries dead and purchase new batteries.

#### CAUTION

In the operation and maintenance of power tools, the safety regulations and standards prescribed in each country must be observed.

## SELECTING ACCESSORIES

The accessories of this machine are listed on page 20. For details regarding each bit type, please contact the HiKOKI Authorized Service Center.

#### Important notice on the batteries for the HiKOKI cordless power tools

Please always use one of our designated genuine batteries. We cannot guarantee the safety and performance of our cordless power tool when used with batteries other than these designated by us, or when the battery is disassembled and modified (such as disassembly and replacement of cells or other internal parts).

#### GUARANTEE

We guarantee HiKOKI Power Tools in accordance with statutory/country specific regulation. This guarantee does not cover defects or damage due to misuse, abuse, or normal wear and tear. In case of complaint, please send the Power Tool, undismantled, with the GUARANTEE CERTIFICATE found at the end of this Handling instruction, to a HiKOKI Authorized Service Center.

#### NOTE

Due to HiKOKI's continuing program of research and development, the specifications herein are subject to change without prior notice.



## TROUBLESHOOTING

### WARNING

- To avoid injury from an accidental start, turn the switch OFF and remove the plug from the power source or remove the battery from the main body before making any adjustments.
- All electrical or mechanical repairs should be done only by qualified service technicians. Contact HiKOKI Authorized Service Center.

#### 1. Cordless Air Compressor

Problem	Possible Cause	Remedy
The compressor does not run.	Loss of power or overheating. There is no electrical power being supplied to compressor or the power switch is in the OFF position.  Thermal overload open.  The power switch is bad. Tank is full of air.	Check for proper use of battery. Check to be sure the battery is installed in and the power switch is in the ON position.  First remove the battery and wait until it becomes cool.  Replace the power switch. Compressor will turn on when tank pressure drops to cut-in pressure.
The thermal overload protector cuts out repeatedly.	A poorly ventilated room is causing the motor to overheat.	Move the compressor to well-ventilated area.
The air receiver pressure drops when the compressor shuts off.	The connections are loose or leaking (fittings, tubing, etc.).  The drain valve is loose. The check valve is leaking.	Check all the connections with soapy water and look for bubbles. Tighten any loose connections until the leak stops. Tighten the drain valve. Take the compressor to a service center. <b>WARNING</b> Do not disassemble check valve while air is in tank - empty the all the air out of the tank before disassembly.
There is excessive moisture in the air discharge.	There is excessive water in the tank. The humidity is high.	Drain the tank to remove water. Move the compressor to an area of less humidity or use an air line filter to reduce moisture discharge in the tank.
Air is leaking from the compressor.	The hose connection is loose or improperly sealed. The air hose is broken or damaged.	Ensure connections are sealed with thread sealing tape and tightened. Replace the air hose.
The compressor runs continuously	The drain valve is open. The power switch is defective. The usage is excessive.	Ensure the drain valve is closed. Take the compressor to a service center. Decrease the amount of tool run-time; the compressor is not large enough to supply the air requirement of the tool.
The compressor vibrates.	The compressor mounting bolts are loose.	Tighten mounting bolts.
The air output is lower than normal.	The inlet valves are broken. The connections are leaking.	Take the compressor to a service center. Apply thread sealing tape to fitting and tighten.
Battery cannot be installed	Attempting to install a battery other than that specified for the tool.	Please install a multi volt type battery.

## 2. Charger

Symptom	Possible cause	Remedy
The charge indicator lamp rapidly flickers purple, and battery charging doesn't begin.	The battery is not inserted all the way.	Insert the battery firmly.
	There is foreign matter in the battery terminal or where the battery is attached.	Remove the foreign matter.
The charge indicator lamp blinks red, and battery charging doesn't begin.	The battery is not inserted all the way.	Insert the battery firmly.
	The battery is overheated.	If left alone, the battery will automatically begin charging if its temperature decreases, but this may reduce battery life. It is recommended that the battery be cooled in a well-ventilated location away from direct sunlight before charging it.
Battery usage time is short even though the battery is fully charged.	The battery's life is depleted.	Replace the battery with a new one.
The battery takes a long time to charge.	The temperature of the battery, the charger, or the surrounding environment is extremely low.	Charge the battery indoors or in another warmer environment.
	The charger's vents are blocked, causing its internal components to overheat.	Avoid blocking the vents.
	The cooling fan is not running.	Contact a HiKOKI Authorized Service Center for repairs.
The USB power lamp has switched off and the USB device has stopped charging.	The battery's capacity has become low.	Replace the battery with one that has capacity remaining.
		Plug the charger's power plug into an electric socket.
USB power lamp does not switch off even though the USB device has finished charging.	The USB power lamp lights up green to indicate that USB charging is possible.	This is not a malfunction.
It is unclear what the charging status of a USB device is, or whether its charging is complete.	The USB power lamp does not switch off even when charging is complete.	Examine the USB device that is charging to confirm its charging status.
Charging of a USB device pauses midway.	The charger was plugged into an electrical socket while the USB device was being charged using the battery as the power source.	This is not a malfunction. The charger pauses USB charging for about 5 seconds when it is differentiating between power sources.
	A battery was inserted into the charger while the USB device was being charged using a power socket as the power source.	
Charging of the USB device pauses midway when the battery and the USB device are being charged at the same time.	The battery has become fully charged.	This is not a malfunction. The charger pauses USB charging for about 5 seconds while it checks whether the battery has successfully completed charging.
Charging of the USB device doesn't start when the battery and the USB device are being charged at the same time.	The remaining battery capacity is extremely low.	This is not a malfunction. When the battery capacity reaches a certain level, USB charging automatically begins.

	EC36DA
	(NN)
	1



377736

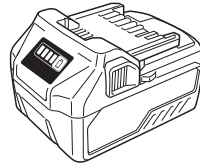

BSL36..18

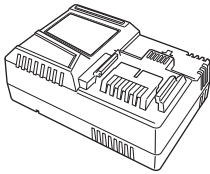

UC18YSL3 (14.4 V-18 V)

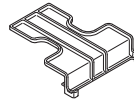

329897

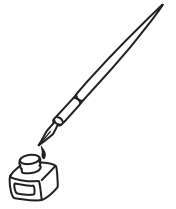

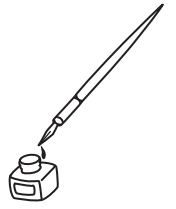

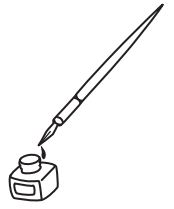

# Koki Holdings Co., Ltd.

Shinagawa Intercity Tower A, 15-1, Konan 2-chome,  
Minato-ku, Tokyo, Japan