

HIKOKI

Cut-Off Machine Model CC 14SF

Handling instructions

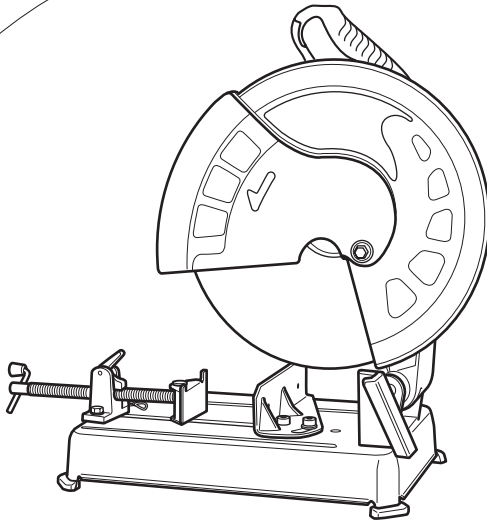

NOTE:

Before using this Electric Power Tool, carefully read through these HANDLING INSTRUCTIONS to ensure efficient, safe operation. It is recommended that these INSTRUCTIONS be kept readily available as an important reference when using this power tool.



GENERAL OPERATIONAL PRECAUTIONS

WARNING! When using electric tools, basic safety precautions should always be followed to reduce the risk of fire, electric shock and personal injury, including the following.

Read all these instructions before operating this product and save these instructions.

For safe operations:

1. Keep work area clean. Cluttered areas and benches invite injuries.
2. Consider work area environment. Do not expose power tools to rain. Do not use power tools in damp or wet locations. Keep work area well lit. Do not use power tools where there is risk to cause fire or explosion.
3. Guard against electric shock. Avoid body contact with earthed or grounded surfaces (e.g. pipes, radiators, ranges, refrigerators).
4. Keep children away. Do not let visitors touch the tool or extension cord. All visitors should be kept away from work area.
5. Store idle tools. When not in use, tools should be stored in a dry, high or locked up place, out of reach of children.
6. Do not force the tool. It will do the job better and safer at the rate for which it was intended.
7. Use the right tool. Do not force small tools or attachments to do the job of a heavy duty tool. Do not use tools for purposes not intended; for example, do not use circular saw to cut tree limbs or logs.
8. Dress properly. Do not wear loose clothing or jewellery, they can be caught in moving parts. Rubber gloves and non-skid footwear are recommended when working outdoors. Wear protecting hair covering to contain long hair.
9. Use eye protection. Also use face or dust mask if the cutting operation is dusty.
10. Connect dust extraction equipment. If devices are provided for the connection of dust extraction and collection facilities ensure these are connected and properly used.
11. Do not abuse the cord. Never carry the tool by the cord or yank it to disconnect it from the receptacle. Keep the cord away from heat, oil and sharp edges.
12. Secure work. Use clamps or a vise to hold the work. It is safer than using your hand and it frees both hands to operate tool.
13. Do not overreach. Keep proper footing and balance at all times.
14. Maintain tools with care. Keep cutting tools sharp and clean for better and safer performance. Follow instructions for lubrication and changing accessories. Inspect tool cords periodically and if damaged, have it repaired by authorized service center. Inspect extension cords periodically and replace, if damaged. Keep handles dry, clean, and free from oil and grease.
15. Disconnect tools. When not in use, before servicing, and when changing accessories such as blades, bits and cutters.

16. Remove adjusting keys and wrenches. Form the habit of checking to see that keys and adjusting wrenches are removed from the tool before turning it on.
17. Avoid unintentional starting. Do not carry a plugged-in tool with a finger on the switch. Ensure switch is off when plugging in.
18. Use outdoor extension leads. When tool is used outdoors, use only extension cords intended for outdoor use.
19. Stay alert. Watch what you are doing. Use common sense. Do not operate tool when you are tired.
20. Check damaged parts. Before further use of the tool, a guard or other part that is damaged should be carefully checked to determine that it will operate properly and perform its intended function. Check for alignment of moving parts, free running of moving parts, breakage of parts, mounting and any other conditions that may affect its operation. A guard or other part that is damaged should be properly repaired or replaced by an authorized service center unless otherwise indicated in this handling instructions. Have defective switches replaced by an authorized service center. Do not use the tool if the switch does not turn it on and off.
21. Warning
The use of any accessory or attachment, other than those recommended in this handling instructions, may present a risk of personal injury.
22. Have your tool repaired by a qualified person. This electric tool is in accordance with the relevant safety requirements. Repairs should only be carried out by qualified persons using original spare parts. Otherwise this may result in considerable danger to the user.

PRECAUTIONS ON USING CUT-OFF MACHINE

1. Before using it, ascertain that the cut-off wheel is not cracked or split. Always make a trial run before use to confirm that the Cut-off Machine does not involve abnormalities.
2. Use the normal cut-off wheel on its normal working surface.
3. Guard against cut-off sparks.
4. Properly replace the cut-off wheel.
5. Always pay attention that the cut-off wheel clamping parts are never impaired. Defective parts will cause damage to the cut-off wheel.
6. Ensure that the workpiece is free of foreign matter such as nails.

SPECIFICATIONS

Voltage (by areas)*		(110V, 115V, 120V, 127V) ~	(220V, 230V, 240V) ~
Input		1640W*	2000W*
Max. cutting dimensions Height × width	90°	115 mm × 130 mm	70 mm × 235 mm
	45°	100 mm × 106 mm	
No-Load Speed		3800 /min	
Max. working peripheral speed		4800 m/min	
Weight		16.5 kg	

* Be sure to check the nameplate on product as it is subject to change by areas.

STANDARD ACCESSORIES

- (1) Cut-off wheel 1
 (2) Hex. bar wrench 1

APPLICATION

Cutting of various metallic materials such as pipes, round bars and shaped steel.

PRIOR TO OPERATION

- Power source**
Ensure that the power source to be utilized conforms to the power requirements specified on the product nameplate.
- Power switch**
Ensure that the power switch is in the OFF position. If the plug is connected to a receptacle while the power switch is in the ON position, the power tool will start operating immediately, which could cause a serious accident.
- Extension cord**
When the work area is removed from the power source, use an extension cord of sufficient thickness and rated capacity. The extension cord should be kept as short as practicable.
- Install the machine on a level flat place, and keep it in a stable condition. Prior to shipping, the equipment is subjected to a rigid factory inspection to prevent electric shocks during operation.
- Since movable portions are secured by tension of a chain while in transit, remove the chain from the chain hook by slightly depressing the switch handle.
- Ascertain that all cut-off wheels are in perfect condition, and do not display scars and cracks.
- Although they have been fully clamped at the factory prior to delivery, reclamp the clamping nuts securely for safety.
- Possible accidents such as a cracked cut-off wheel is prevented by this protective cover (wheel cover). Although it has been fully clamped at the factory prior to delivery, securely reclamp the mounting screws for safety.

- When replacing the cut-off wheel, ensure that the replacement cutting wheel has a designed circumferential speed in excess of 4800 m/min.
- Ensure that the bar spanner used for tightening or removing the cut-off wheel is not attached to the machine.
- Ensure that the material is securely fastened with the vise. If it is not, a serious accident could be caused if the material comes loose or the cut-off wheel breaks during operation.
- Continued cutting without noticing a cracked or split cut-off wheel may prove to be very hazardous. Before starting operation, make a trial run to confirm that no abnormalities are involved.
Trial run periods:
When replacing the cut-off wheel Over 3 minutes.
When starting routine work Over 1 minute.
- Rotate the cut-off wheel to inspect any facial deflection. A heavy deflection will cause the cut-off wheel to shift.

CUTTING PROCEDURES

CAUTION:

It is dangerous to remove or install the workpiece while the cut-off wheel turning.

1. Operating the switch

The switch is switched on by manually pulling the trigger and cut off by releasing the trigger to the original location. The switch can operate continuously, even after releasing the trigger, by pushing the stopper after pulling the trigger. The stopper can be removed by pulling the trigger again and the switch is cut off with the release of the trigger.

2. Cutting

- Rotate the cut-off wheel, gently press down the handle, and bring the cut-off wheel close to the cutting material.
- When the cut-off wheel contacts the cutting material, gently press down the handle further and start cutting.
- When cutting (or designated slotting) is completed, raise the handle and restore it to its original position.
- At the termination of each cutting process, turn OFF the switch to stop rotation and proceed with the subsequent cutting job.

CAUTION:

It does not necessarily cut rapidly when putting more force on the handle.

Too much force on the handle will put excessive pressure on the motor and reduce its capacity.

Do not fail to switch OFF the switch after operation is completed and pull the plug out.

MOUNTING AND DISMOUNTING THE CUT-OFF WHEEL

1. Dismounting the cut-off wheel (Fig. 1)

(1) Press the stopper and loosen the bolt with a hex. bar wrench.

CAUTION:

When the mounting shaft for cut-off wheel cannot be fixed with pressing the stopper, turn the bolt with a hex. bar wrench while pressing the stopper. The mounting shaft for cut-off wheel is fixed when the stopper has been lowered.

(2) Remove the bolt, washer (A), and the wheel washer and detach the cut-off wheel.

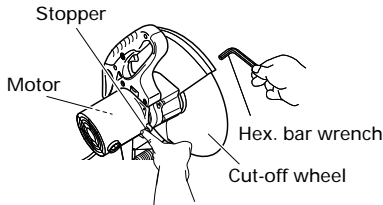

Fig. 1

2. Mounting the cut-off wheel

Thoroughly remove dust from the wheel washers and bolt then mount the wheel by following the dismounting procedures in reverse order.

CAUTION:

Confirm that the stopper which was used for installation and removal of the cut-off wheel has returned to the retract position.

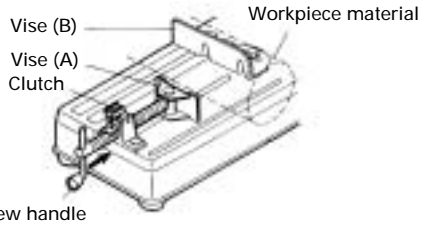

Fig. 2

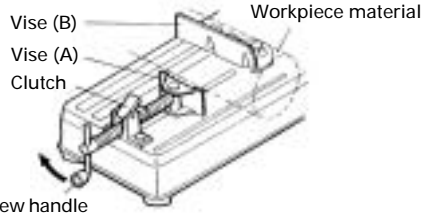

Fig. 3

2. Cutting at angles (Fig. 4 and 5)

(1) The machine permits cutting at angles of 45° or 60°.

(2) Loosen the two M10 hexagon socket head bolts on the vice (B), then set the working surface on the vice-jaw at any angles of 0°, 30°, or 45° as shown in Fig. 5. Upon completion of setting, securely tighten the two M10 hexagon socket head bolts.

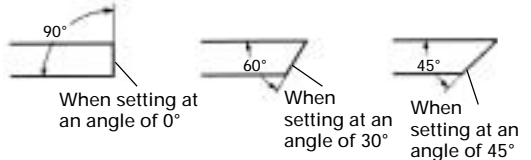

Fig. 4

HOW TO OPERATE

1. Procedure for fixing the cutting material (Fig. 2 and 3)

Place the workpiece material between vise (A) and vise (B), raise the clutch and push the screw handle to bring vise (A) lightly into contact with the workpiece material, as shown in Fig. 2.

Then, turn the clutch down, and securely fix the workpiece material in position by turning the screw handle. When the cutting job is completed, turn the screw handle 2 or 3 times to loosen the vise, and remove the workpiece material, as shown in Fig. 3.

CAUTION:

Never remove or install a workpiece material while the cut-off wheel is rotating, to avoid personal injury.

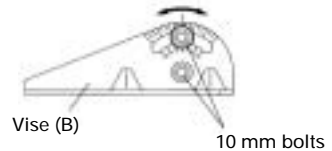

Fig. 5

- (3) When wide material is cut with angle, it will be firmly camped by fixing a steel board like Fig. 6 to the vise (B).

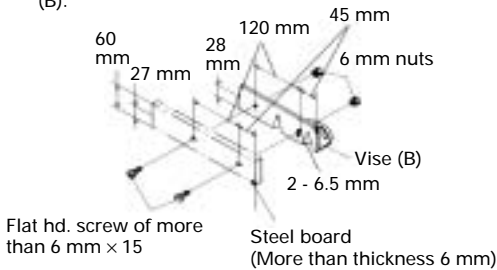

Fig. 6

3. Moving the stationary vise-jaw (Fig. 7)

The vise opening is set at the maximum of 170 mm when shipped from the factory. In case an opening of more than 170 mm is required, move the vise to the position shown by the chain line after unscrewing the two bolts. The maximum opening can be set in two steps 205 mm and 240 mm. When the cutting material is excessively wide, the vise can be effectively used by repositioning the stationary side of the vise-jaws.

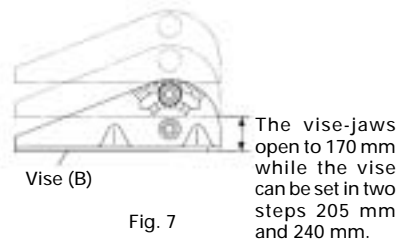

Fig. 7

4. How to use metallic block (Fig. 8)

When the cut-off wheel has a reduced outer diameter, insert between the vise (A) and (B) a metallic block slightly smaller than the dimension of workpiece being cut to use the cut-off wheel economically.

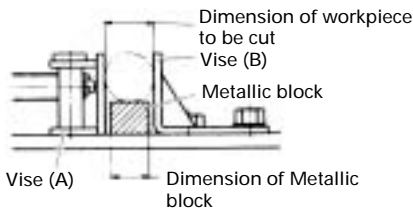

Fig. 8

1. Replacing a cut-off wheel

When the cut-off wheel has already become dull while continually using, the unnecessary load is got from the motor. Consequently, redress or replace a dull cut-off wheel to ensure grinding efficiency.

2. Inspecting the carbon brushes (Fig. 9)

The motor employs carbon brushes which are consumable parts. Since an excessively worn carbon brush can result in motor trouble, replace the carbon brush with a new one having the same carbon brush No. shown in the figure when it becomes worn to or near the "wear limit". In addition, always keep carbon brushes clean and ensure that they slide freely within the brush holders.

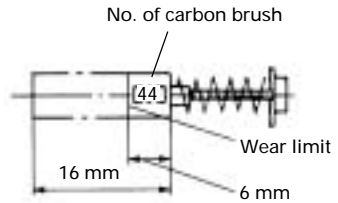

Fig. 9

3. Inspecting the mounting screws

Regularly inspect all mounting screws and ensure that they are properly tightened. Should any of the screws be loose, retighten them immediately. Failure to do so could result in serious hazard.

4. Lubrication

Supply oil in the following oil supply points once a month so as to keep the machine workable for a long time.

Oil supply points

- Rotary part of shaft
- Rotary part of vise
- Slide way of vise (A)

5. Cleaning

Wipe off chip and waste adhered to the machine with a cloth or the like time to time. Be careful not to make the motor portion wet with oil or water.

6. Service parts list

CAUTION:

Repair, modification and inspection of HiKOKI Power Tools must be carried out by an HiKOKI Authorized Service Center.

This Parts List will be helpful if presented with the tool to the HiKOKI Authorized Service Center when requesting repair or other maintenance.

In the operation and maintenance of power tools, the safety regulations and standards prescribed in each country must be observed.

MODIFICATIONS:

HiKOKI Power Tools are constantly being improved and modified to incorporate the latest technological advancements.

Accordingly, some parts (i.e. code numbers and/or design) may be changed without prior notice.

MAINTENANCE AND INSPECTION

CAUTION:

Be sure to switch off and pull off the plug from the power outlet before inspection and maintenance.

NOTE:

Due to HiKOKI's continuing program of research and development, the specifications herein are subject to change without prior notice.

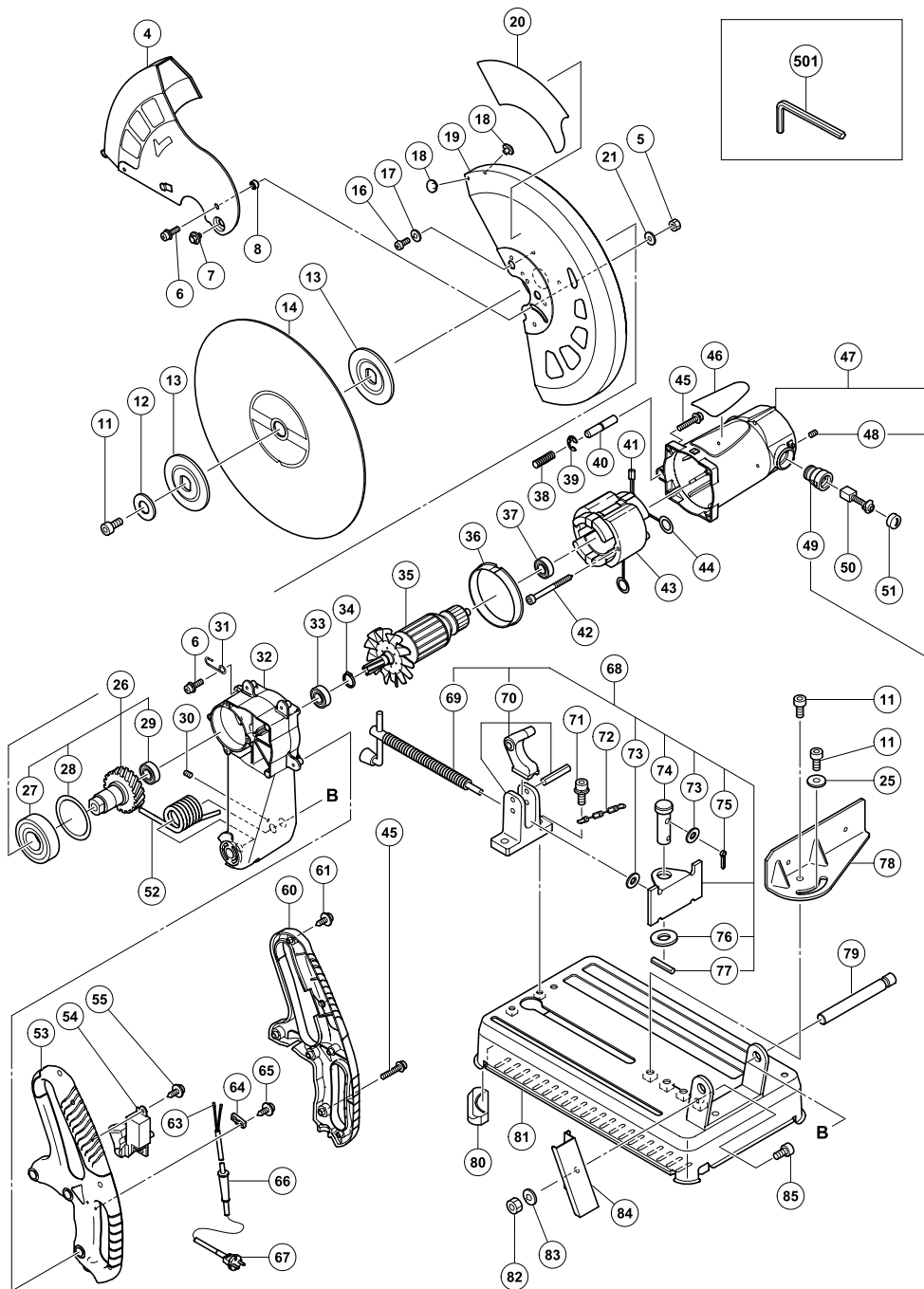

ITEM NO.	PART NAME
4	SUB COVER (A)
5	NUT M5
6	MACHINE SCREW (W/WASHERS) M5 × 16
7	FLANGE BOLT (A)
8	COVER SPACER
11	HEX. SOCKET HD.BOLT M10 × 20
12	WASHER (A)
13	WHEEL WASHER (A)
14	CUT-OFF WHEEL ASS'Y
16	MACHINE SCREW M5 × 12
17	SPRING WASHER M5
18	COVER BUSH
19	WHEEL COVER (A)
20	BRAND LABEL
21	BOLT WASHER M5
25	BOLT WASHER M10
26	SPINDLE ASS'Y
27	BALL BEARING 6306ZZCM
28	BEARING PLATE
29	BALL BEARING
30	SEAL LOCK HEX. SOCKET SET SCREW M5 × 16
31	CHAIN HOOK
32	GEAR CASE
33	BALL BEARING 6002VVC
34	RETAINING RING FOR D15 SHAFT
35	ARMATURE ASS'Y
36	FAN GUIDE
37	BALL BEARING
38	GAUGE SPRING
39	RETAINING RING (E-TYPE) FOR D6 SHAFT
40	STOPPER PIN
41	TUBE(D)
42	HEX. HD. TAPPING SCREW D5 × 75
43	STATOR ASS'Y
44	BRUSH TERMINAL
45	MACHINE SCREW (W/WASHERS) M5 × 35
46	NAME PLATE
47	HOUSING ASS'Y
48	HEX. E5SOCKET SET SCREW M5 × 8
49	BRUSH HOLDER
50	CARBON BRUSH
51	BRUSH CAP
52	SPRING
53	HANDLE
54	SWITCH
55	TAPPING SCREW (W/FLANGE)
60	HANDLE COVER
61	TAPPING SCREW (W/FLANGE) D4 × 16
63	TUBE(D)
64	CORD CLIP
65	TAPPING SCREW (W/FLANGE) D4 × 16
66	CORD ARMOR
67	CORD
68	WISE ASS'Y
69	SCREW
70	SCREW HOLDER
71	HEX. SOCKET HD. BOLT (W/WASHERS) M8 × 25

ITEM NO.	PART NAME
72	CHAIN
73	BOLT WASHER M8
74	BOLT
75	SPLIT PIN D3 × 15
76	WASHER M16
77	ROLL PIN D5 × 25
78	WISE (B)
79	HINGE SHAFT
80	BASE RUBBER
81	BASE
82	NUT M8
83	SPRING WASHER M8
84	SPARK CHUTE
85	HEX. SOCKET HD. BOLT M8 × 20
501	HEX. BAR WRENCH 8MM

Koki Holdings Co., Ltd.

806
Code No. C99142211
Printed in China