

HIKOKI

CN 18DSL

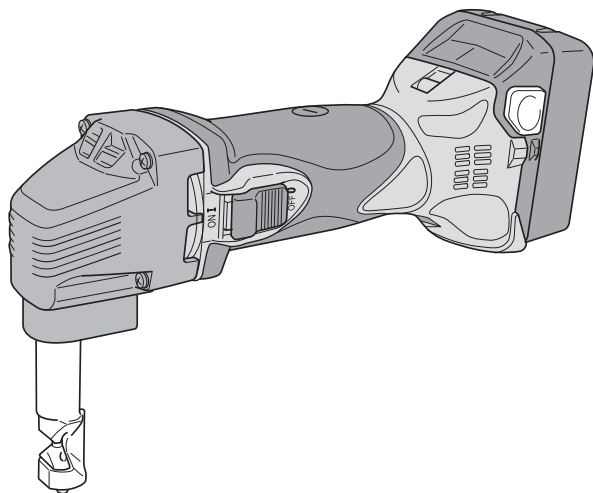

Handling instructions

GENERAL POWER TOOL SAFETY WARNINGS

WARNING

Read all safety warnings and all instructions.

Failure to follow the warnings and instructions may result in electric shock, fire and/or serious injury.

Save all warnings and instructions for future reference.

The term "power tool" in the warnings refers to your mains-operated (corded) power tool or battery-operated (cordless) power tool.

1) Work area safety

- a) **Keep work area clean and well lit.**
Cluttered or dark areas invite accidents.
- b) **Do not operate power tools in explosive atmospheres, such as in the presence of flammable liquids, gases or dust.**
Power tools create sparks which may ignite the dust or fumes.
- c) **Keep children and bystanders away while operating a power tool.**
Distractions can cause you to lose control.

2) Electrical safety

- a) **Power tool plugs must match the outlet. Never modify the plug in any way. Do not use any adapter plugs with earthed (grounded) power tools.**
Unmodified plugs and matching outlets will reduce risk of electric shock.
- b) **Avoid body contact with earthed or grounded surfaces, such as pipes, radiators, ranges and refrigerators.**
There is an increased risk of electric shock if your body is earthed or grounded.
- c) **Do not expose power tools to rain or wet conditions.**
Water entering a power tool will increase the risk of electric shock.
- d) **Do not abuse the cord. Never use the cord for carrying, pulling or unplugging the power tool. Keep cord away from heat, oil, sharp edges or moving parts.**
Damaged or entangled cords increase the risk of electric shock.
- e) **When operating a power tool outdoors, use an extension cord suitable for outdoor use.**
Use of a cord suitable for outdoor use reduces the risk of electric shock.
- f) **If operating a power tool in a damp location is unavoidable, use a residual current device (RCD) protected supply.**
Use of an RCD reduces the risk of electric shock.

3) Personal safety

- a) **Stay alert, watch what you are doing and use common sense when operating a power tool. Do not use a power tool while you are tired or under the influence of drugs, alcohol or medication.**
A moment of inattention while operating power tools may result in serious personal injury.
- b) **Use personal protective equipment. Always wear eye protection.**
Protective equipment such as dust mask, non-skid safety shoes, hard hat, or hearing protection used for appropriate conditions will reduce personal injuries.

- c) **Prevent unintentional starting. Ensure the switch is in the off position before connecting to power source and/or battery pack, picking up or carrying the tool.**

Carrying power tools with your finger on the switch or energising power tools that have the switch on invites accidents.

- d) **Remove any adjusting key or wrench before turning the power tool on.**

A wrench or a key left attached to a rotating part of the power tool may result in personal injury.

- e) **Do not overreach. Keep proper footing and balance at all times.**

This enables better control of the power tool in unexpected situations.

- f) **Dress properly. Do not wear loose clothing or jewellery. Keep your hair, clothing and gloves away from moving parts.**

Loose clothes, jewellery or long hair can be caught in moving parts.

- g) **If devices are provided for the connection of dust extraction and collection facilities, ensure these are connected and properly used.**

Use of dust collection can reduce dust-related hazards.

4) Power tool use and care

- a) **Do not force the power tool. Use the correct power tool for your application.**

The correct power tool will do the job better and safer at the rate for which it was designed.

- b) **Do not use the power tool if the switch does not turn it on and off.**

Any power tool that cannot be controlled with the switch is dangerous and must be repaired.

- c) **Disconnect the plug from the power source and/or the battery pack from the power tool before making any adjustments, changing accessories, or storing power tools.**

Such preventive safety measures reduce the risk of starting the power tool accidentally.

- d) **Store idle power tools out of the reach of children and do not allow persons unfamiliar with the power tool or these instructions to operate the power tool.**

Power tools are dangerous in the hands of untrained users.

- e) **Maintain power tools. Check for misalignment or binding of moving parts, breakage of parts and any other condition that may affect the power tool's operation.**

If damaged, have the power tool repaired before use.

- f) **Keep cutting tools sharp and clean.**

Properly maintained cutting tools with sharp cutting edges are less likely to bind and are easier to control.

- g) **Use the power tool, accessories and tool bits etc. in accordance with these instructions, taking into account the working conditions and the work to be performed.**

Use of the power tool for operations different from those intended could result in a hazardous situation.

5) Battery tool use and care

- a) **Recharge only with the charger specified by the manufacturer.**

A charger that is suitable for one type of battery pack may create a risk of fire when used with another battery pack.

- b) **Use power tools only with specifically designated battery packs.**

Use of any other battery packs may create a risk of injury and fire.

- c) **When battery pack is not in use, keep it away from other metal objects, like paper clips, coins, keys, nails, screws or other small metal objects, that can make a connection from one terminal to another.**

Shorting the battery terminals together may cause burns or a fire.

- d) **Under abusive conditions, liquid may be ejected from the battery; avoid contact. If contact accidentally occurs, flush with water. If liquid contacts eyes, additionally seek medical help.**

Liquid ejected from the battery may cause irritation or burns.

6) Service

- a) **Have your power tool serviced by a qualified repair person using only identical replacement parts.**

This will ensure that the safety of the power tool is maintained.

PRECAUTION

Keep children and infirm persons away.

When not in use, tools should be stored out of reach of children and infirm persons.

PRECAUTIONS ON USING CORDLESS NIBBLER

1. Ensure that the power switch is in the OFF position. If the battery is connected to a power tool while the power switch is in the ON position, the power tool will start operating immediately, which could cause a serious accident.
2. Beware of sharp panel edges. The edge of the plate just cut by the nibbler is very sharp. Take care in not getting hurt by the sharp edge.
3. If shavings get into the machine, it will produce problems or accidents. Do not place the machine on the shavings.
4. Shavings are hot immediately after they are cut. Never touch them with bare hands.
5. Die Inspection Inspect for looseness of the M8 hexagon socket set screw used for mounting the die holder, the M3 machine screws used for mounting the die (see **Fig. 3**) and the M5 hexagon socket set screws used for mounting the punch (see **Fig. 3**). Caution should be exercised because, if any of these screws are loose, not only does cutting performance deteriorate but the machine can also be damaged.
6. Lubrication Before use, carefully lubricate the sliding surfaces around the die and punch (see **Fig. 3**) with a suitable amount of machine oil or spindle oil.
7. Cutting
 - Never try to cut materials that are too large for the capacity of the machine since this may cause damage.
 - Applying cutting oil (spindle oil, machine oil, and so on) along the shearing line may decrease wear of the punch and die.Use care to prevent cutting oil adhering to the housing since the surface may be damaged.

CAUTION ON LITHIUM-ION BATTERY

To extend the lifetime, the lithium-ion battery equips with the protection function to stop the output.

In the cases of 1 to 3 described below, when using this product, even if you are pulling the switch, the motor may stop. This is not the trouble but the result of protection function.

1. When the battery power remaining runs out, the motor stops. In such a case, charge it up immediately.
2. If the tool is overloaded, the motor may stop. In this case, release the switch of tool and eliminate causes of overloading. After that, you can use it again.
3. If the battery is overheated under overload work, the battery power may stop. In this case, stop using the battery and let the battery cool. After that, you can use it again.

Furthermore, please heed the following warning and caution.

WARNING

In order to prevent any battery leakage, heat generation, smoke emission, explosion and ignition beforehand, please be sure to heed the following precautions.

1. Make sure that swarf and dust do not collect on the battery.
 - During work make sure that swarf and dust do not fall on the battery.
 - Make sure that any swarf and dust falling on the power tool during work do not collect on the battery.
 - Do not store an unused battery in a location exposed to swarf and dust.
 - Before storing a battery, remove any swarf and dust that may adhere to it and do not store it together with metal parts (screws, nails, etc.).
2. Do not pierce battery with a sharp object such as a nail, strike with a hammer, step on, throw or subject the battery to severe physical shock.
3. Do not use an apparently damaged or deformed battery.
4. Do not use the battery in reverse polarity.
5. Do not connect directly to an electrical outlets or car cigarette lighter sockets.
6. Do not use the battery for a purpose other than those specified.
7. If the battery charging fails to complete even when a specified recharging time has elapsed, immediately stop further recharging.
8. Do not put or subject the battery to high temperatures or high pressure such as into a microwave oven, dryer, or high pressure container.
9. Keep away from fire immediately when leakage or foul odor are detected.
10. Do not use in a location where strong static electricity generates.
11. If there is battery leakage, foul odor, heat generated, discolored or deformed, or in any way appears abnormal during use, recharging or storage, immediately remove it from the equipment or battery charger, and stop use.

CAUTION

1. If liquid leaking from the battery gets into your eyes, do not rub your eyes and wash them well with fresh clean water such as tap water and contact a doctor immediately. If left untreated, the liquid may cause eye-problems.
2. If liquid leaks onto your skin or clothes, wash well with clean water such as tap water immediately. There is a possibility that this can cause skin irritation.
3. If you find rust, foul odor, overheating, discolor, deformation, and/or other irregularities when using the battery for the first time, do not use and return it to your supplier or vendor.

WARNING

If a conductive foreign matter enters in the terminal of lithium ion battery, the battery may be shorted, causing fire. When storing the lithium ion battery, obey surely the rules of following contents.

- Do not place conductive debris, nail and wires such as iron wire and copper wire in the storage case.
- To prevent shorting from occurring, load the battery in the tool or insert securely the battery cover for storing until the ventilator is not seen.

REGARDING LITHIUM-ION BATTERY TRANSPORTATION

When transporting a lithium-ion battery, please observe the following precautions.

WARNING

Notify the transporting company that a package contains a lithium-ion battery, inform the company of its power output and follow the instructions of the transportation company when arranging transport.

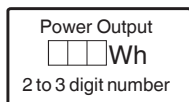

- Lithium-ion batteries that exceed a power output of 100Wh are considered to be in the freight classification of Dangerous Goods and will require special application procedures.
- For transportation abroad, you must comply with international law and the rules and regulations of the destination country.











SYMBOLS

WARNING

The following show symbols used for the machine. Be sure that you understand their meaning before use.

	CN18DSL : Cordless Nibbler
	Read all safety warnings and all instructions.

	Always wear eye protection.
V	Rated voltage
/min	Revolution or reciprocations per minute
I	Switching ON
O	Switching OFF
	Warning
	Disconnect the battery
	Battery capacity
	Remaining battery indicator switch
	The battery remaining power is nearly empty. Recharge the battery soonest possible
	The battery remaining power is a half.
	The battery remaining power is enough.

STANDARD ACCESSORIES

In addition to the main unit (1 unit), the package contains the accessories listed on page 8.

Standard accessories are subject to change without notice.

APPLICATIONS

Cutting and pocket cutting mild steel, stainless steel, copper and aluminium plates corrugated plates and trapezoidal plates.

SPECIFICATIONS

Model	CN18DSL	
Voltage	18 V	
Cutting capacity	Mild Steel plate (400 N / mm ²)	1.6 mm
	Stainless steel plate (600 N / mm ²)	1.2 mm
	Aluminium plate (200 N / mm ²)	2.3 mm
Number of strokes at no load	2500 /min	
Minimum cutting radius	40 mm	
Width of nibbling groove	5 mm	
Weight	2.1 kg (BSL1850)	

NOTE

Due to HIKOKI's continuing program of research and development, the specifications herein are subject to change without prior notice.

CHARGING

Battery and battery charger are not included with this product.

Before using the power tool, charge the battery as follows.

1. Connect to the power source. (Fig. 2)

When charging the battery from an AC power source

- Connect the charger's power cord to the receptacle. When connecting the plug of the charger to a receptacle, the pilot lamp will blink in red (At 1-second intervals).

CAUTION

Do not use the electrical cord if damaged. Have it repaired immediately.

When charging the battery from a DC 12V in-car power source (UC18YML2)

- Secure the battery charger in place in the car. Use the strap supplied with the battery charger to fasten the battery charger in place and prevent it from moving inadvertently. (See Fig. 12)

CAUTION

Do not place the battery charger or battery under the driver's seat. Secure the battery charger in place to prevent it from moving inadvertently as this may lead to an accident.



Fig. 12

- Insert the cigarette lighter connecting plug into the cigarette lighter socket. If the plug is loose and falls out of the cigarette lighter socket, repair the socket. As the socket may be faulty, you are recommended to contact your local car dealer. Continued use of the socket may result in an accident due to overheating.
- ### 2. Insert the battery into the charger. (Fig. 2)
- Firmly insert the battery into the charger.
- ### 3. Charging
- When inserting a battery in the charger, charging will commence and the pilot lamp will light continuously in red.
- When the battery becomes fully recharged, the pilot lamp will blink in red. (At 1-second intervals) (See Table 1)
- Pilot lamp indication
- The indications of the pilot lamp will be as shown in Table 1, according to the condition of the charger or the rechargeable battery.

Table 1

Indications of the pilot lamp					
The pilot lamp lights or blinks.	Before charging	Blinks (red)	Lights for 0.5 seconds. Does not light for 0.5 seconds.		
	While charging	Lights (red)	Lights continuously		
	Charging complete	Blinks (red)	Lights for 0.5 seconds. Does not light for 0.5 seconds.		
	Charging impossible	Flickers (red)	Lights for 0.1 seconds. Does not light for 0.1 seconds.		Malfunction in the battery or the charger
	Overheat standby	Lights (green) (UC18YML2)	Lights continuously		Battery overheated. Unable to charge. (Charging will commence when battery cools)
		Blinks (red) (UC18YFSL)	Lights for 1 second. Does not light for 0.5 seconds.		
Charging with in-car power source impossible (UC18YML2)	Blinks (green)	Lights for 0.5 seconds. Does not light for 0.5 seconds.		Malfunction in the battery or the charger	

NOTE: When standby for cooling battery, UC18YML2 / UC18YFSL cools the overheated battery by cooling fan. (However, the cooling fan does not function when charging the battery with a DC 12 V in-car power source.)

- Regarding the temperatures and charging time of the battery.
The temperatures and charging time will become as shown in **Table 2**.

Table 2

Battery		Charger	UC18YFSL	UC18YML2 (AC/DC)*1
Charging voltage		V	14.4 – 18	
Weight		kg	0.5	0.7
Temperatures at which the battery can be recharged			0°C – 50°C	
Charging time for battery capacity, approx.(At 20°C)				
1.3 Ah	min.		20	20 / 50
1.5 Ah	min.		22	22 / 60
2.0 Ah	min.		30	30 / 80
2.5 Ah	min.		35	35 / 100
3.0 Ah	min.		45	45 / 120
4.0 Ah	min.		60	60 / 160
5.0 Ah	min.		75	75 / 200
Number of battery cells			4 – 10	

*1 AC power supply / DC 12 V (in-car) power supply

NOTE

The recharging time may vary according to the ambient temperature and power source voltage.

<UC18YML2>

Especially, using a DC 12 V in-car power source may require longer recharging time at high temperatures.

CAUTION

When the battery charger has been continuously used, the battery charger will be heated, thus constituting the cause of the failures. Once the charging has been completed, give 15 minutes rest until the next charging.

4. Disconnect the charger's power cord from the receptacle or cigarette lighter socket.

5. Hold the charger firmly and pull out the battery.

NOTE

Be sure to pull out the battery from the charger after use, and then keep it.

CAUTION

- If the battery is charged while it is heated because it has been left for a long time in a location subject to direct sunlight or because the battery has just been used, the pilot lamp of the charger lights up green or lights for 1 second, does not light for 0.5 seconds (off for 0.5 seconds). In such a case, first let the battery cool, then start charging.
- When the pilot lamp flickers in red (at 0.2-seconds intervals), check for and take out any foreign objects in the charger's battery connector. If there are no foreign objects, it is probable that the battery or charger is malfunctioning. Take it to your authorized Service Center.
- Since the built-in micro computer takes about 3 seconds to confirm that the battery being charged with charger is taken out, wait for a minimum of 3 seconds before reinserting it to continue charging. If the battery is reinserted within 3 seconds, the battery may not be properly charged.
- Check the voltage of the in-car power source when the pilot lamp flickers in green (every 0.2 seconds) continuously. (UC18YML2)
If the voltage is 12 V or lower, it indicates that the car battery has weakened and cannot be charged.
- If the pilot lamp does not blink in red (every second) even though the charger cord or cigarette lighter connecting plug is connected to the power, it indicates that the protection circuit of the charger may be activated.

Remove the cord or plug from the power and then connect it again after 30 seconds or so. If this does not cause the pilot lamp to blink in red (every second), please take the charger to the HiKOKI Authorized Service Center.

MOUNTING AND OPERATION

Action	Figure	Page
Removing and inserting the battery	1	9
Charging	2	9
Replacing punch and die*1	3	9
Switch operation	4	10
Remaining battery indicator	5	10
Cutting plates	6	10
Pocket cutting	7	11
Switch cutting direction	8	11
Cutting corrugated and trapezoidal plates	9	11
Selecting accessories	—	13

***1 Punch and die replacement (see Fig. 3)**

CAUTION

During the following operations, use care to prevent dirt adhering inside the gear cover ㊸, inside the die holder ㊹ and around the piston.

(1) Punch ㊺ replacement

- Loosen the M8 hexagon socket set screw ㊻ mounting the die holder and remove the die holder.
- Loosen the M5 hexagon socket set screw ㊼ fastening the punch to the piston ㊽ and pull out the punch ㊺.
- Insert the new punch ㊾ while aligning the taper hole ㊿ of the punch and the direction of the M5 hexagon socket set screw, then securely tighten the hexagon socket set screw.

(2) Die ㊿ replacement

Loosen the 2 machine screws ① and replace the die ㊿.

(3) Lubrication

When the above replacement operations are completed, apply a suitable amount of machine oil to the sliding surfaces around the punch and die and operate the machine without a load.

Service Life of the Punch and Die

Wear and damage to the cutting edges of the punch and die can greatly influence the cutting operation. Under normal usage, the service life of the punch and die is as shown in the table below. Replace the punch and die promptly when the end of the service life approaches. The punch and die should be replaced at the same time.

Cutting materials	Service life cutting lengths of punch and die
1.6 mm Mild steel plates	300 m
1.6 mm Mild steel corrugated and trapezoidal plates	50 m
1.2 mm stainless steel plates	200 m

When the machine is used according to the service life indicated in the above table, the punch will have abrasions as shown in the enlarged diagram of the worn punch tip in **Fig. 10**. This is when the punch and die should be replaced.

CAUTION

If the punch and die are used longer than the specified service life, the die holder will be subject to excessive stress and may break off.

When a 1.6 mm mild steel trapezoidal plate is cut, wear will be especially quick. Replace the punch and die as soon as possible after reaching the service life.

Caution must be exercised since any error in this operation can result in the deformed nail of the carbon brush and may cause motor trouble at an early stage.

6. Storage

Store the cordless disc grinder in a place in which the temperature is less than 40°C, and out of reach of children.

NOTE

Storing lithium-ion batteries.

Make sure the lithium-ion batteries have been fully charged before storing them.

Prolonged storage (3 months or more) of batteries with a low charge may result in performance deterioration, significantly reducing battery usage time or rendering the batteries incapable of holding a charge.

However, significantly reduced battery usage time may be recovered by repeatedly charging and using the batteries two to five times.

If the battery usage time is extremely short despite repeated charging and use, consider the batteries dead and purchase new batteries.

CAUTION

In the operation and maintenance of power tools, the safety regulations and standards prescribed in each country must be observed.

MAINTENANCE AND INSPECTION

1. Checking punch and die

A worn or defective punch and die will greatly decrease work efficiency.

Check and replace them periodically. Refer to "Replacing punch and die".

2. Inspecting the mounting screws

Regularly inspect all mounting screws and ensure that they are properly tightened. Should any of the screws be loose, retighten them immediately. Failure to do so could result in serious hazard.

3. Maintenance of the motor

The motor unit winding is the very "heart" of the power tool. Exercise due care to ensure the winding does not become damaged and/or wet with oil or water.

4. Inspecting the carbon brushes (Fig. 11)

The motor employs carbon brushes which are consumable parts. Since an excessively worn carbon brush can result in motor trouble, replace the carbon brush with new ones when it becomes worn to or near the "wear limit" (⊖). In addition, always keep carbon brushes clean and ensure that they slide freely within the brush holders.

NOTE

When replacing the carbon brush with a new one, be sure to use the HiKOKI Carbon Brush Code No. 999054.

5. Replacing carbon brushes (Fig. 11)

Take out the carbon brush by first removing the brush cap and then hooking the protrusion of the carbon brush with a flat head screw driver, etc.

When installing the carbon brush, choose the direction so that the nail (⊗) of the carbon brush agrees with the contact portion (⊕) outside the brush tube. Then push it in with a finger. Lastly, install the brush cap.

CAUTION

Be absolutely sure to insert the nail of the carbon brush into the contact portion outside the brush tube. (You can insert whichever one of the two nails provided).

Important notice on the batteries for the HiKOKI cordless power tools

Please always use one of our designated genuine batteries. We cannot guarantee the safety and performance of our cordless power tool when used with batteries other than these designated by us, or when the battery is disassembled and modified (such as disassembly and replacement of cells or other internal parts).

NOTE

Due to HiKOKI's continuing program of research and development, the specifications herein are subject to change without prior notice.

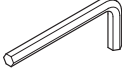
		
CN18DSL (NN)	1	1

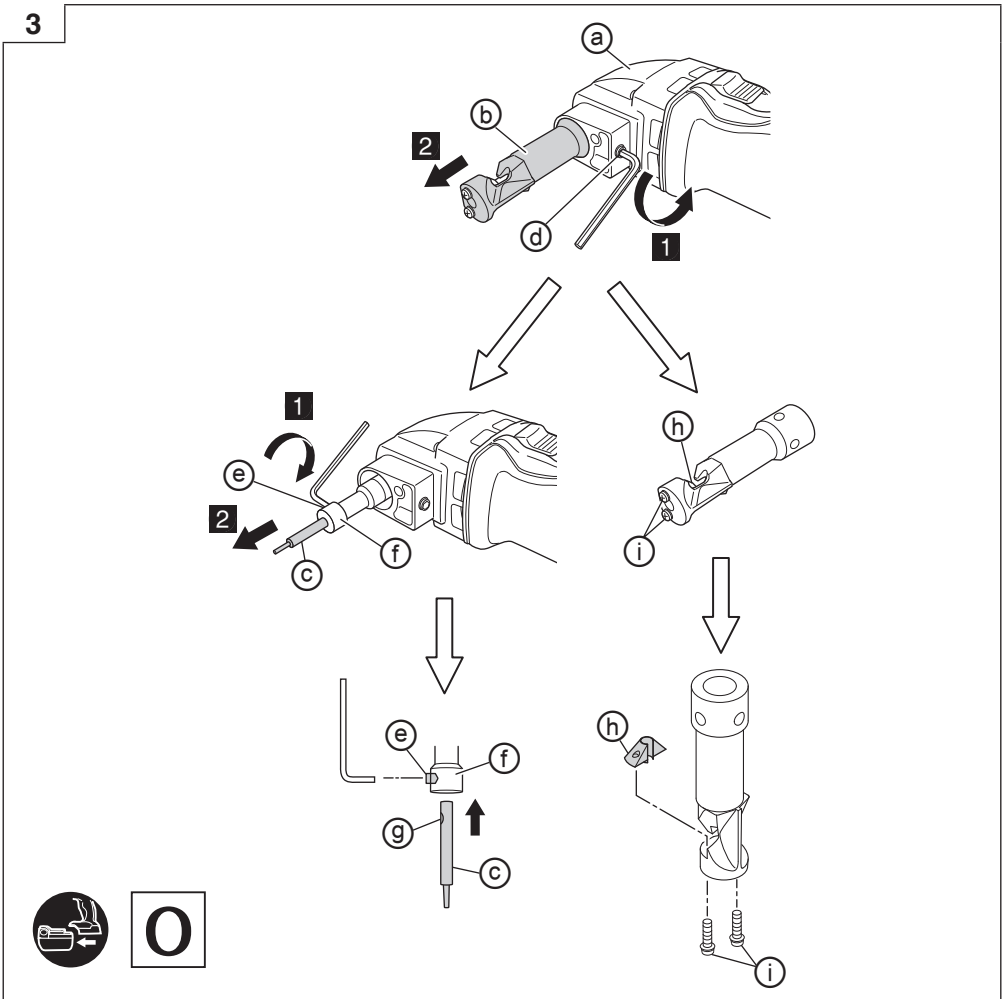
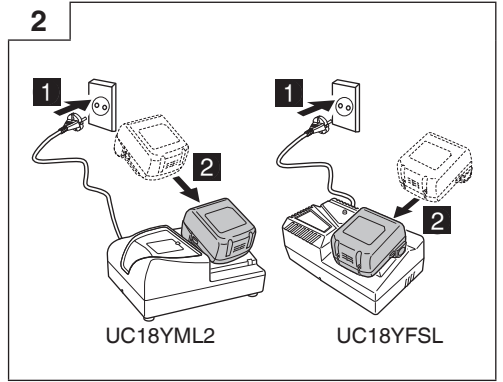
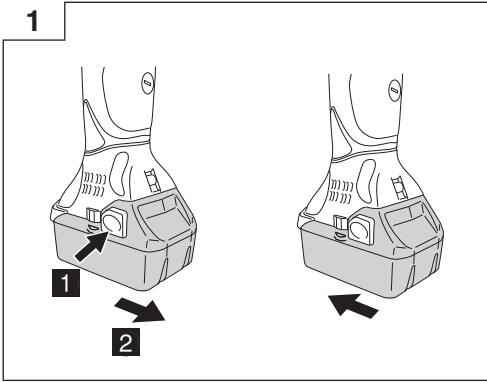

4

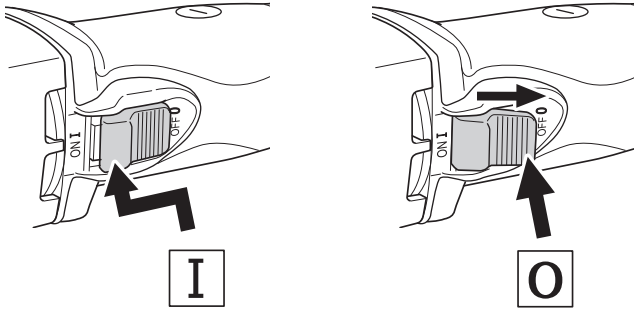

5

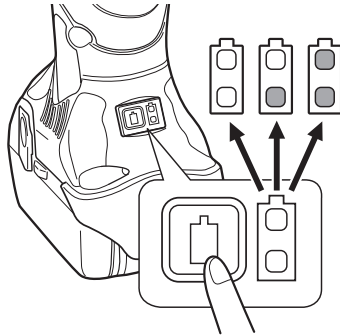

6

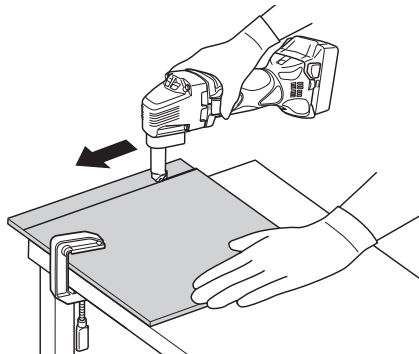

7

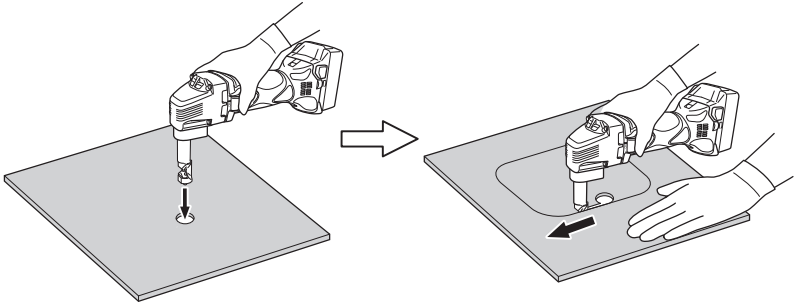
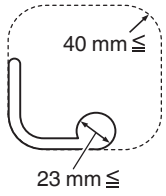

8

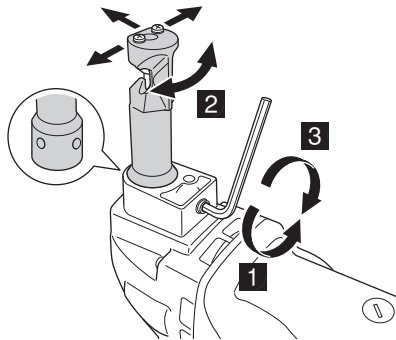

9

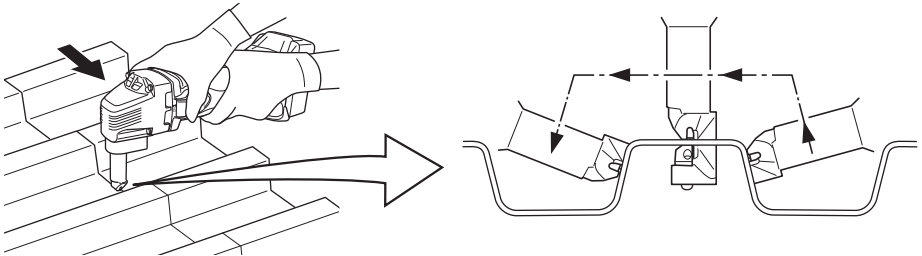

10

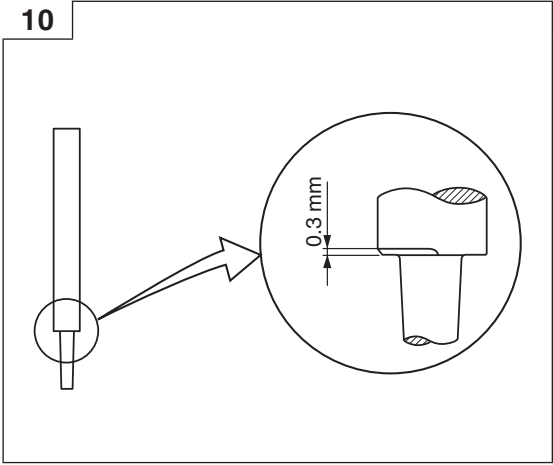

11

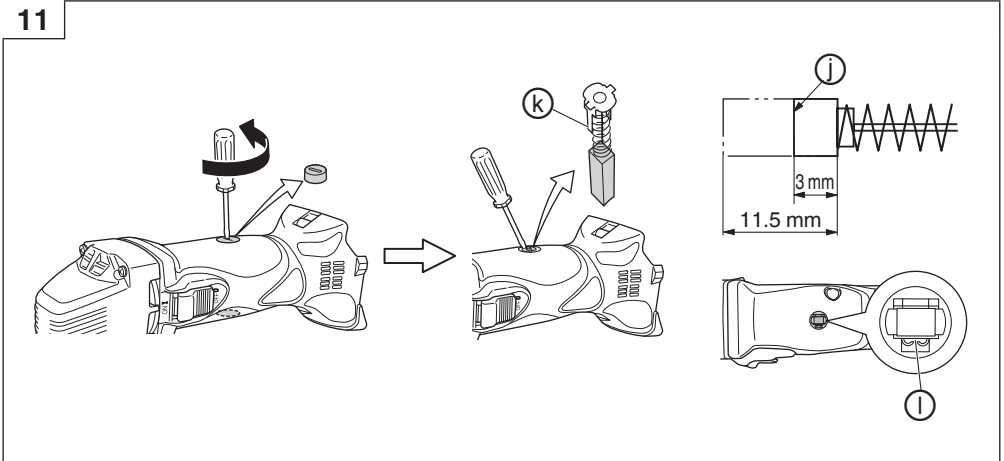

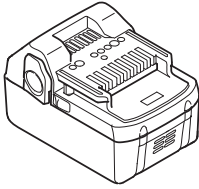

18V (Li-ion)

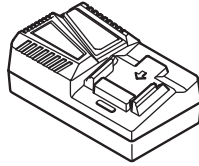

UC18YFSL
(14.4V – 18V)

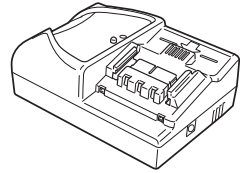

UC18YML2
(14.4V – 18V)

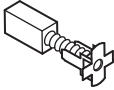

999054



990666

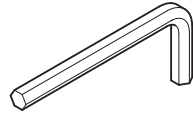

944458



998030



998039

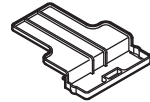

329897

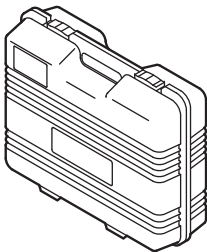

339992

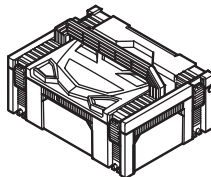

336471

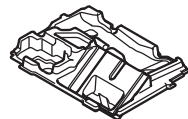

339993

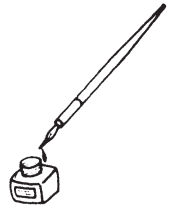

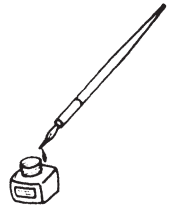

Koki Holdings Co., Ltd.

Shinagawa Intercity Tower A, 15-1, Konan 2-chome,
Minato-ku, Tokyo, Japan