

HiKOKI

DS 18DC · DS 36DC · DV 18DC · DV 36DC

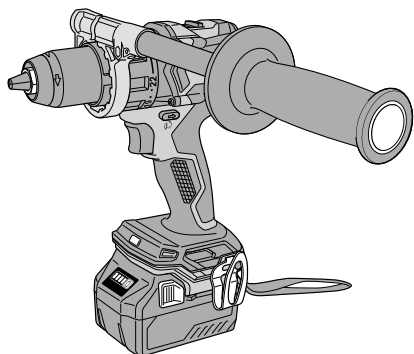

DS18DC
DS36DC

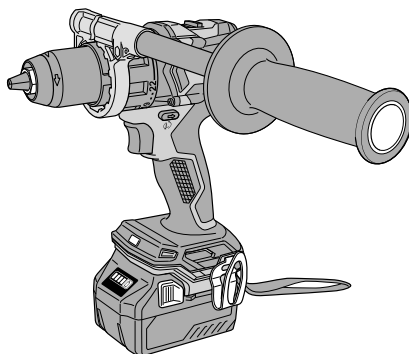

DV18DC
DV36DC



Handling instructions

1

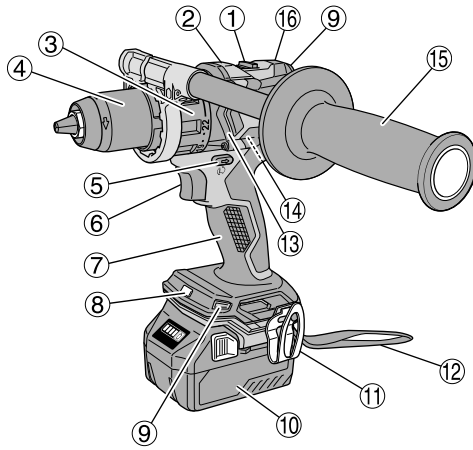

DS18DC, DS36DC, DV18DC, DV36DC

2

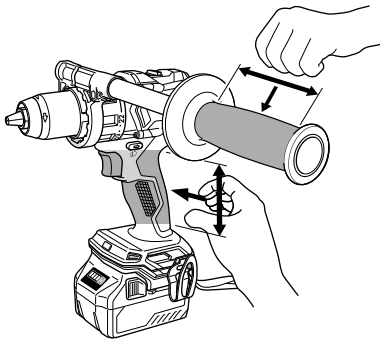

3

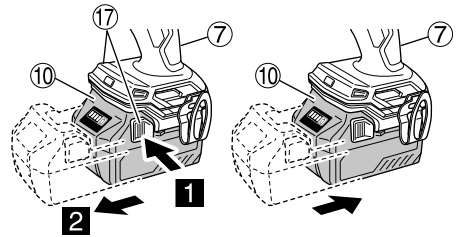

4

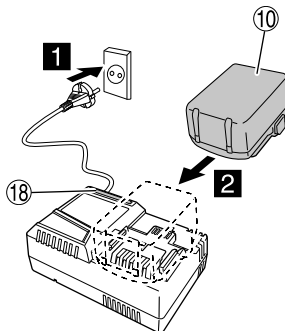

UC18YSL3

5

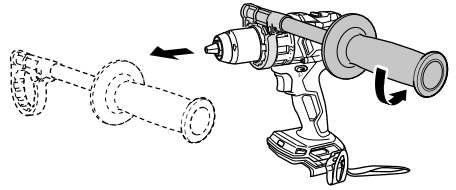
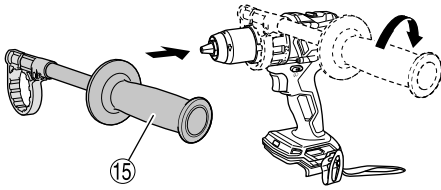

6

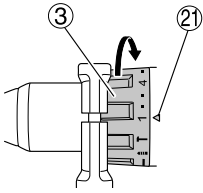

Min.

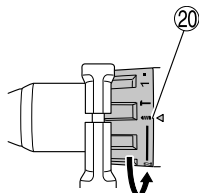

Max.

7

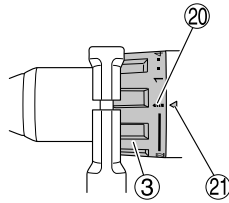

DS18DC
DS36DC

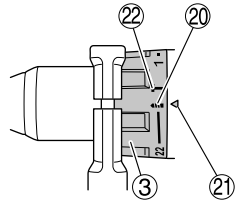

DV18DC
DV36DC

8

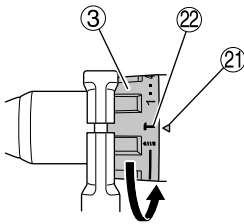

DV18DC
DV36DC



9

2

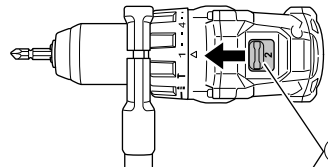

1

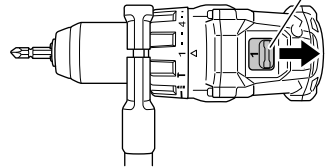

10

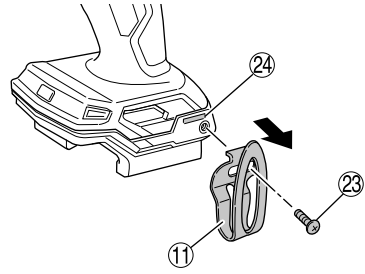
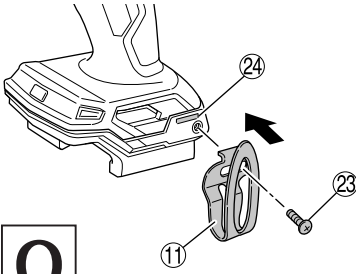

O

11

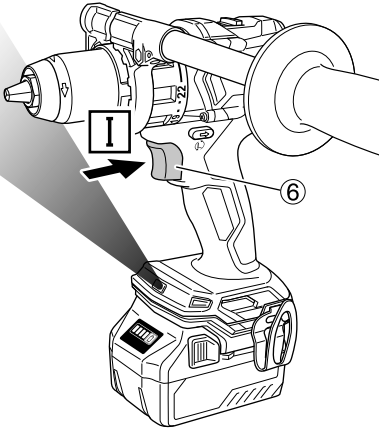

12

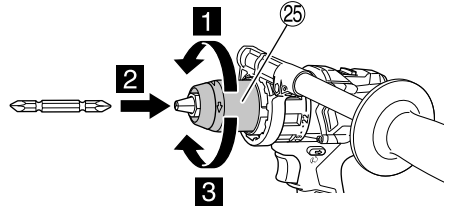

O

13

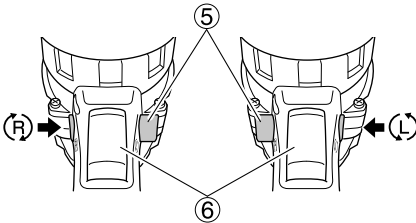

O

14

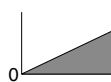
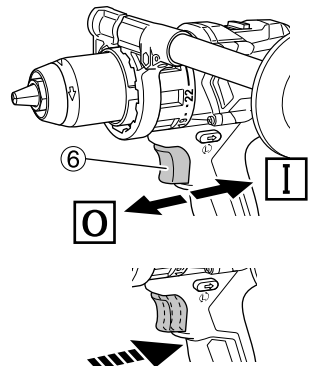

DS18DC, DV18DC: Ls 500 /min
 Hs 2000 /min
 DS36DC, DV36DC: Ls 550 /min
 Hs 2200 /min

15

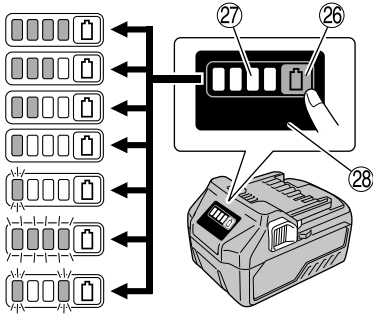

16

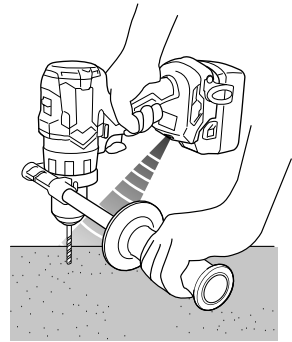
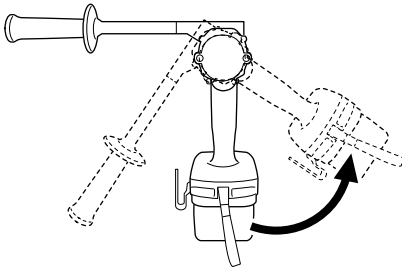

17

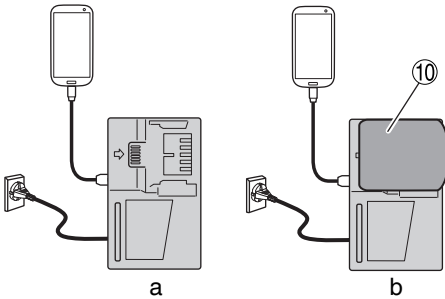

18

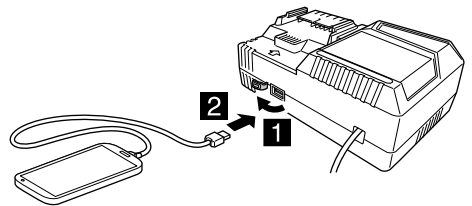

19

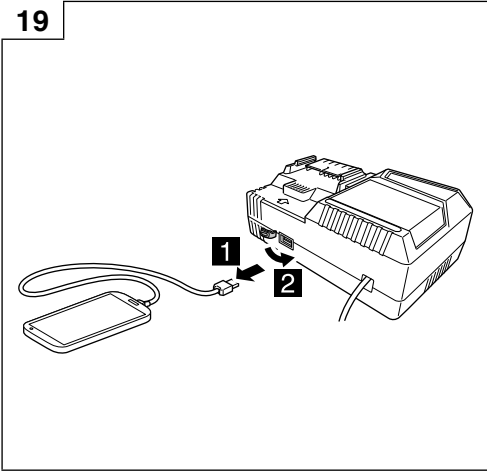

GENERAL POWER TOOL SAFETY WARNINGS

WARNING

Read all safety warnings, instructions, illustrations and specifications provided with this power tool.

Failure to follow all instructions listed below may result in electric shock, fire and/or serious injury.

Save all warnings and instructions for future reference.

The term "power tool" in the warnings refers to your mains-operated (corded) power tool or battery-operated (cordless) power tool.

1) Work area safety

- a) **Keep work area clean and well lit.**
Cluttered or dark areas invite accidents.
- b) **Do not operate power tools in explosive atmospheres, such as in the presence of flammable liquids, gases or dust.**
Power tools create sparks which may ignite the dust or fumes.
- c) **Keep children and bystanders away while operating a power tool.**
Distractions can cause you to lose control.

2) Electrical safety

- a) **Power tool plugs must match the outlet. Never modify the plug in any way. Do not use any adapter plugs with earthed (grounded) power tools.**
Unmodified plugs and matching outlets will reduce risk of electric shock.
- b) **Avoid body contact with earthed or grounded surfaces, such as pipes, radiators, ranges and refrigerators.**
There is an increased risk of electric shock if your body is earthed or grounded.
- c) **Do not expose power tools to rain or wet conditions.**
Water entering a power tool will increase the risk of electric shock.
- d) **Do not abuse the cord. Never use the cord for carrying, pulling or unplugging the power tool. Keep cord away from heat, oil, sharp edges or moving parts.**
Damaged or entangled cords increase the risk of electric shock.
- e) **When operating a power tool outdoors, use an extension cord suitable for outdoor use.**
Use of a cord suitable for outdoor use reduces the risk of electric shock.
- f) **If operating a power tool in a damp location is unavoidable, use a residual current device (RCD) protected supply.**
Use of an RCD reduces the risk of electric shock.

3) Personal safety

- a) **Stay alert, watch what you are doing and use common sense when operating a power tool. Do not use a power tool while you are tired or under the influence of drugs, alcohol or medication.**
A moment of inattention while operating power tools may result in serious personal injury.
- b) **Use personal protective equipment. Always wear eye protection.**
Protective equipment such as a dust mask, non-skid safety shoes, hard hat or hearing protection used for appropriate conditions will reduce personal injuries.

- c) **Prevent unintentional starting. Ensure the switch is in the off-position before connecting to power source and/or battery pack, picking up or carrying the tool.**

Carrying power tools with your finger on the switch or energising power tools that have the switch on invites accidents.

- d) **Remove any adjusting key or wrench before turning the power tool on.**
A wrench or a key left attached to a rotating part of the power tool may result in personal injury.
- e) **Do not overreach. Keep proper footing and balance at all times.**
This enables better control of the power tool in unexpected situations.
- f) **Dress properly. Do not wear loose clothing or jewellery. Keep your hair and clothing away from moving parts.**
Loose clothes, jewellery or long hair can be caught in moving parts.
- g) **If devices are provided for the connection of dust extraction and collection facilities, ensure these are connected and properly used.**
Use of dust collection can reduce dust-related hazards.
- h) **Do not let familiarity gained from frequent use of tools allow you to become complacent and ignore tool safety principles.**
A careless action can cause severe injury within a fraction of a second.

4) Power tool use and care

- a) **Do not force the power tool. Use the correct power tool for your application.**
The correct power tool will do the job better and safer at the rate for which it was designed.
- b) **Do not use the power tool if the switch does not turn it on and off.**
Any power tool that cannot be controlled with the switch is dangerous and must be repaired.
- c) **Disconnect the plug from the power source and/or remove the battery pack, if detachable, from the power tool before making any adjustments, changing accessories, or storing power tools.**
Such preventive safety measures reduce the risk of starting the power tool accidentally.
- d) **Store idle power tools out of the reach of children and do not allow persons unfamiliar with the power tool or these instructions to operate the power tool.**
Power tools are dangerous in the hands of untrained users.
- e) **Maintain power tools and accessories. Check for misalignment or binding of moving parts, breakage of parts and any other condition that may affect the power tool's operation. If damaged, have the power tool repaired before use.**
Many accidents are caused by poorly maintained power tools.
- f) **Keep cutting tools sharp and clean.**
Properly maintained cutting tools with sharp cutting edges are less likely to bind and are easier to control.
- g) **Use the power tool, accessories and tool bits etc. in accordance with these instructions, taking into account the working conditions and the work to be performed.**
Use of the power tool for operations different from those intended could result in a hazardous situation.
- h) **Keep handles and grasping surfaces dry, clean and free from oil and grease.**

Slippery handles and grasping surfaces do not allow for safe handling and control of the tool in unexpected situations.

5) Battery tool use and care

a) Recharge only with the charger specified by the manufacturer.

A charger that is suitable for one type of battery pack may create a risk of fire when used with another battery pack.

b) Use power tools only with specifically designated battery packs.

Use of any other battery packs may create a risk of injury and fire.

c) When battery pack is not in use, keep it away from other metal objects, like paper clips, coins, keys, nails, screws or other small metal objects, that can make a connection from one terminal to another.

Shorting the battery terminals together may cause burns or a fire.

d) Under abusive conditions, liquid may be ejected from the battery; avoid contact. If contact accidentally occurs, flush with water. If liquid contacts eyes, additionally seek medical help.

Liquid ejected from the battery may cause irritation or burns.

e) Do not use a battery pack or tool that is damaged or modified.

Damaged or modified batteries may exhibit unpredictable behaviour resulting in fire, explosion or risk of injury.

f) Do not expose a battery pack or tool to fire or excessive temperature.

Exposure to fire or temperature above 130°C may cause explosion.

g) Follow all charging instructions and do not charge the battery pack or tool outside the temperature range specified in the instructions.

Charging improperly or at temperatures outside the specified range may damage the battery and increase the risk of fire.

6) Service

a) Have your power tool serviced by a qualified repair person using only identical replacement parts.

This will ensure that the safety of the power tool is maintained.

b) Never service damaged battery packs.

Service of battery packs should only be performed by the manufacturer or authorized service providers.

PRECAUTION

Keep children and infirm persons away.

When not in use, tools should be stored out of reach of children and infirm persons.

CORDLESS DRIVER DRILL / IMPACT DRIVER DRILL SAFETY WARNINGS

Safety instructions for all operations

<DV18DC / DV36DC>

a) Wear ear protectors when impact drilling.

Exposure to noise can cause hearing loss.

<DS18DC / DS36DC / DV18DC / DV36DC>

b) Use the auxiliary handle(s).

Loss of control can cause personal injury.

c) Brace the tool properly before use.

This tool produces a high output torque and without properly bracing the tool during operation, loss of control may occur resulting in personal injury.

d) Hold the power tool by insulated gripping surfaces, when performing an operation where the cutting accessory may contact hidden wiring.

Cutting accessory contacting a "live" wire may make exposed metal parts of the power tool "live" and could give the operator an electric shock.

Safety instructions when using long drill bits

a) Never operate at higher speed than the maximum speed rating of the drill bit.

At higher speeds, the bit is likely to bend if allowed to rotate freely without contacting the workpiece, resulting in personal injury.

b) Always start drilling at low speed and with the bit tip in contact with the workpiece.

At higher speeds, the bit is likely to bend if allowed to rotate freely without contacting the workpiece, resulting in personal injury.

c) Apply pressure only in direct line with the bit and do not apply excessive pressure.

Bits can bend causing breakage or loss of control, resulting in personal injury.

ADDITIONAL SAFETY WARNINGS

1. Make sure that the area to be drilled is absolutely free of any hidden obstructions including electrical wiring, water, or gas pipes. Drilling into the aforementioned may result in electric shock or short circuit, gas leak or other hazards that can cause serious accidents or injuries.
2. Make sure to securely hold the tool during operation. Failure to do so can result in accidents or injuries (**Fig. 2**).
3. When using the tool, make sure the side handle is attached and firmly secured. If not firmly secured, the tool may jerk out of position when overburdened, resulting in injury.
4. During operation, make sure to firmly hold the tool's handle and side handle with both hands. Failure to do so may result in injury.
5. Secure the workpiece. A workpiece clamped with clamping devices or in a vice is held more secure than by hand.
6. Setting up and checking the work environment. Check if the work environment is suitable by following the precaution.
7. When mounting a bit into the keyless chuck, tighten the sleeve adequately. If the sleeve is not tight, the bit may slip or fall out, causing injury.
8. When changing the rotational speed with the shift knob, confirm that the switch is off. Changing the speed while the motor is rotating will damage the gears.
9. The clutch dial cannot be set between the numerals "1, 4, 7 ... 22" or the dots, and do not use with the clutch dial numeral between "22" and the line at the middle of the drill mark. Doing so may cause damage.
10. Always use this unit with clockwise rotation, when using it as impact drill. (DV18DC, DV36DC only)
11. Resting the unit after continuous work.
12. The power tool is equipped with a temperature protection circuit to protect the motor. Continuous work may cause the temperature of the unit to rise, activating the temperature protection circuit and automatically stopping operation. If this happens, allow the power tool to cool before resuming use.
13. The motor may stop in the event the tool is overloaded. In this should occur, release the tool's switch and eliminate the cause of the overload.
14. Do not touch metal parts of the tool body, bits, drills, or swarf immediately after use, as these will be hot.
15. The motor rotation may be locked to cease while the unit is used as drill. While operating the driver drill, take care not to lock the motor.

16. The use of the battery in a cold condition (below 0 degree Centigrade) can sometimes result in the weakened tightening torque and reduced amount of work. This, however, is a temporary phenomenon, and returns to normal when the battery warms up.
17. Install securely the hook. Unless the hook is securely installed, it may cause an injury while using. When electing to carry the tool hooked to your hip belt, make sure to detach the tool bit and side handle. Failure to do so may result in unexpected injury.
18. Do not look directly into the light. Such actions could result in eye injury.
Wipe off any dirt or grime attached to the lens of the LED light with a soft cloth, being careful not to scratch the lens.
Scratches on the lens of the LED light can result in decreased brightness.
19. When working at elevated locations, clear the area of other people and aware of conditions below you.
20. Always charge the battery at a temperature of 0°C–40°C. A temperature of less than 0°C will result in over charging which is dangerous. The battery cannot be charged at a temperature higher than 40°C.
The most suitable temperature for charging is that of 20°C–25°C.
21. Do not use the charger continuously.
When one charging is completed, leave the charger for about 15 minutes before the next charging of battery.
22. Do not allow foreign matter to enter the hole for connecting the rechargeable battery.
23. Never disassemble the rechargeable battery and charger.
24. Never short-circuit the rechargeable battery. Shortcircuiting the battery will cause a great electric current and overheat. It results in burn or damage to the battery.
25. Do not dispose of the battery in fire. If the battery is burnt, it may explode.
26. Bring the battery to the shop from which it was purchased as soon as the post-charging battery life becomes too short for practical use. Do not dispose of the exhausted battery.
27. Do not insert object into the air ventilation slots of the charger. Inserting metal objects or inflammables into the charger air ventilation slots will result in electrical shock hazard or damaged charger.
28. When using this unit continuously, the unit may overheat, leading to damage in the motor and switch. Therefore, whenever the housing becomes hot, give the tool a break for a while.
29. Make sure that the battery is installed firmly. If it is at all loose it could come off and cause an accident.
30. Do not use the product if the tool or the battery terminals (battery mount) are deformed.
Installing the battery could cause a short circuit that could result in smoke emission or ignition.
31. Keep the tool's terminals (battery mount) free of swarf and dust.
 - Prior to use, make sure that swarf and dust have not collected in the area of the terminals.
 - During use, try to avoid swarf or dust on the tool from falling on the battery.
 - When suspending operation or after use, do not leave the tool in an area where it may be exposed to falling swarf or dust.
Doing so could cause a short circuit that could result in smoke emission or ignition.
32. Always use the tool and battery at temperatures between -5°C and 40°C.

CAUTION ON LITHIUM-ION BATTERY

To extend the lifetime, the lithium-ion battery equips with the protection function to stop the output.

In the cases of 1 to 3 described below, when using this product, even if you are pulling the switch, the motor may stop. This is not the trouble but the result of protection function.

1. When the battery power remaining runs out, the motor stops.
In such a case, charge it up immediately.
2. If the tool is overloaded, the motor may stop. In this case, release the switch of tool and eliminate causes of overloading. After that, you can use it again.
3. If the battery is overheated under overload work, the battery power may stop.
In this case, stop using the battery and let the battery cool. After that, you can use it again.

Furthermore, please heed the following warning and caution.

WARNING

In order to prevent any battery leakage, heat generation, smoke emission, explosion and ignition beforehand, please be sure to heed the following precautions.

1. Make sure that swarf and dust do not collect on the battery.
 - During work make sure that swarf and dust do not fall on the battery.
 - Make sure that any swarf and dust falling on the power tool during work do not collect on the battery.
 - Do not store an unused battery in a location exposed to swarf and dust.
 - Before storing a battery, remove any swarf and dust that may adhere to it and do not store it together with metal parts (screws, nails, etc.).
2. Do not pierce battery with a sharp object such as a nail, strike with a hammer, step on, throw or subject the battery to severe physical shock.
3. Do not use an apparently damaged or deformed battery.
4. Do not use the battery for a purpose other than those specified.
5. If the battery charging fails to complete even when a specified recharging time has elapsed, immediately stop further recharging.
6. Do not put or subject the battery to high temperatures or high pressure such as into a microwave oven, dryer, or high pressure container.
7. Keep away from fire immediately when leakage or foul odor are detected.
8. Do not use in a location where strong static electricity generates.
9. If there is battery leakage, foul odor, heat generated, discolored or deformed, or in any way appears abnormal during use, recharging or storage, immediately remove it from the equipment or battery charger, and stop use.
10. Do not immerse the battery or allow any fluids to flow inside. Conductive liquid ingress, such as water, can cause damage resulting in fire or explosion. Store your battery in a cool, dry place, away from combustible and flammable items. Corrosive gas atmospheres must be avoided.

CAUTION

1. If liquid leaking from the battery gets into your eyes, do not rub your eyes and wash them well with fresh clean water such as tap water and contact a doctor immediately.
If left untreated, the liquid may cause eye-problems.
2. If liquid leaks onto your skin or clothes, wash well with clean water such as tap water immediately.
There is a possibility that this can cause skin irritation.
3. If you find rust, foul odor, overheating, discolor, deformation, and/or other irregularities when using the battery for the first time, do not use and return it to your supplier or vendor.

WARNING

If a conductive foreign matter enters in the terminal of lithium ion battery, the battery may be shorted, causing fire. When storing the lithium ion battery, obey surely the rules of following contents.

- Do not place conductive debris, nail and wires such as iron wire and copper wire in the storage case.
- To prevent shorting from occurring, load the battery in the tool or insert securely the battery cover for storing until the ventilator is not seen.

REGARDING LITHIUM-ION BATTERY TRANSPORTATION

When transporting a lithium-ion battery, please observe the following precautions.

WARNING

Notify the transportation company that a package contains a lithium-ion battery, inform the company of its power output and follow the instructions of the transportation company when arranging transport.

- Lithium-ion batteries that exceed a power output of 100 Wh are considered to be in the freight classification of Dangerous Goods and will require special application procedures.
- For transportation abroad, you must comply with international law and the rules and regulations of the destination country.

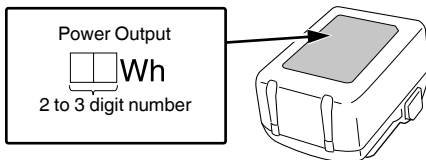

USB DEVICE CONNECTION PRECAUTIONS (UC18YSL3)

When an unexpected problem occurs, the data in a USB device connected to this product may be corrupted or lost. Always make sure to back up any data contained in the USB device prior to use with this product.

Please be aware that our company accepts absolutely no responsibility for any data stored in a USB device that is corrupted or lost, nor for any damage that may occur to a connected device.

WARNING

- Prior to use, check the connecting USB cable for any defect or damage. Using a defective or damaged USB cable can cause smoke emission or ignition.
- When the product is not being used, cover the USB port with the rubber cover. Buildup of dust etc. in the USB port can cause smoke emission or ignition.

NOTE

- There may be an occasional pause during USB recharging.
- When a USB device is not being charged, remove the USB device from the charger. Failure to do so may not only reduce the battery life of a USB device, but may also result in unexpected accidents.
- It may not be possible to charge some USB devices, depending on the type of device.

NAMES OF PARTS (Fig. 1–Fig. 19)

①	Shift knob	⑮	Side handle
②	Name plate	⑯	Housing
③	Clutch dial	⑰	Latch
④	Keyless chuck	⑱	Charge indicator lamp
⑤	Push button	⑲	Pilot lamp
⑥	Trigger switch	⑳	Drill mark
⑦	Handle	㉑	Triangle mark
⑧	LED light	㉒	Hammer mark
⑨	Ventilation holes	㉓	Screw
⑩	Battery	㉔	Groove
⑪	Hook	㉕	Sleeve
⑫	Strap	㉖	Remaining battery indicator switch
⑬	Gear case	㉗	Remaining battery indicator lamp
⑭	Motor	㉘	Display panel

SYMBOLS

WARNING

The following show symbols used for the machine. Be sure that you understand their meaning before use.

	DS18DC, DS36DC: Cordless Driver Drill DV18DC, DV36DC: Cordless Impact Driver Drill
	To reduce the risk of injury, user must read instruction manual.
	Direct current
	Rated voltage
	No-load speed
	Impact rate
	Low speed
	High speed
	Brick
	Wood
	Metal
	Machine screw
	Wood screw
	Drill chuck capacity
	Weight
	Drilling
	Impact drilling
	Switching ON

	Switching OFF
	Disconnect the battery
	Change rotation speed – High speed
	Change rotation speed – Low speed
	Clockwise rotation
	Counterclockwise rotation
	Warning

Battery

	Lights ; The battery remaining power is over 75%.
	Lights ; The battery remaining power is 50%–75%.
	Lights ; The battery remaining power is 25%–50%.
	Lights ; The battery remaining power is less than 25%.
	Blinks ; The battery remaining power is nearly empty. Recharge the battery soonest possible.
	Blinks ; Output suspended due to high temperature. Remove the battery from the tool and allow it to fully cool down.
	Blinks ; Output suspended due to failure or malfunction. The problem may be the battery so please contact your dealer.

STANDARD ACCESSORIES

In addition to the main unit (1 unit), the package contains the accessories listed on page 16.
Standard accessories are subject to change without notice.

APPLICATIONS

<DS18DC, DS36DC>

- Driving and removing of machine screws, wood screws, tapping screws, etc.
- Drilling of various metals
- Drilling of various woods

<DV18DC, DV36DC>

- Drilling of brick and concrete block, etc.
- Driving and removing of machine screws, wood screws, tapping screws, etc.
- Drilling of various metals
- Drilling of various woods

SPECIFICATIONS

1. Power tool
The specifications of this machine are listed in the Table on page 15.

<DS36DC, DV36DC>

* Existing batteries (BSL3660/3620/3626, BSL18xx and BSL14xx series) cannot be used with this tool. Use a multi volt type battery.

NOTE

Due to HiKOKI's continuing program of research and development, the specifications herein are subject to change without prior notice.

2. Battery

Model	BSL1840M	BSL1850MA	BSL36A18
Voltage	18 V	18 V	36 V / 18 V*
Battery capacity	4.0 Ah	5.0 Ah	2.5 Ah / 5.0 Ah*

* The tool itself will automatically switch over.

CHARGING

Before using the power tool, charge the battery as follows.

1. **Connect the charger's power cord to the receptacle.**
When connecting the plug of the charger to a receptacle, the charge indicator lamp will blink in red (At 1- second intervals).
2. **Insert the battery into the charger.**
Firmly insert the battery into the charger as shown in Fig. 4 (on page 2).
3. **Charging**
When inserting a battery in the charger, the charge indicator lamp will blink in blue.
When the battery becomes fully recharged, the charge indicator lamp will light up in green. (See Table 1)

CAUTION

- If the battery is charged while it is heated because it has been left for a long time in a location subject to direct sunlight or because the battery has just been used, the charge indicator lamp of the charger lights for 0.3 seconds, does not light for 0.3 seconds (off for 0.3 seconds). In such a case, first let the battery cool, then start charging.
- When the charge indicator lamp flickers (at 0.2-second intervals), check for and take out any foreign objects in the charger's battery connector. If there are no foreign objects, it is probable that the battery or charger is malfunctioning. Take it to your authorized Service Center.

MOUNTING AND OPERATION

Action	Figure	Page
Removing and inserting the battery	3	2
Charging	4	2
Installing / Removing the side handle	5	3
Tightening torque adjustment	6	3
Selecting the drill position	7	3
Selecting the impact position	8	3
Change rotation speed	9	3
Mounting and removing the hook	10	4
How to use the LED light	11	4
Mounting the bit	12	4
Reversing the rotational direction	13	4
Switch operation	14	4
Remaining battery indicator	15	5
Charging a USB device from a electrical outlet	17-a	5
Charging a USB device and battery from a electrical outlet	17-b	5
How to recharge USB device	18	5
When charging of USB device is completed	19	6
Selecting accessories	—	16

RFC (Reactive force control)

This product features RFC.

This stops the motor automatically if the tool is jerking excessively.

The LED light flashes to indicate that RFC has been activated.

If this occurs, release your finger from the switch before restarting. (Fig.16)



NOTE

- RFC may not always activate under certain working conditions or situations.
- Take care to hold the tool firmly to prevent any jerking motion.
- RFC may also activate if you change position suddenly while holding the tool.

LED LIGHT WARNING SIGNALS

This product features functions that are designed to protect the tool itself as well as the battery. If any of the safeguard functions are triggered during operation, the LED light will blink as described in **Table 3**. When any of the safeguard functions are triggered, immediately remove your finger from the switch and follow the instructions described under corrective action.

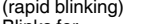
Table 3

Safeguard Function	LED Light Display	Corrective Action
Overburden Protection	On 0.1 second/off 0.1 second  (rapid blinking) Blinks for approximately 3 seconds after the switch has been released.	If the operating with the shift knob set on "2", adjust to "1" and continue operation. Remove the cause of the overburdening.
RFC	On 0.15 second/off 0.15 second x 3 times/Off 2 seconds  Blinks for approximately 3 seconds after the switch has been released.	Remove the problem causing the tool to jerk excessively. When operating the tool, firmly hold the tool to make sure it doesn't jerk.
Temperature Protection	On 0.5 second/Off 0.5 second  (slow blinking) Blinks while protection is in effect.	Allow the tool and battery to thoroughly cool.

MAINTENANCE AND INSPECTION

WARNING

Be sure to turned off the switch and remove the battery before maintenance and inspection.

1. Inspecting the tool

Since use of as dull tool will degrade efficiency and cause possible motor malfunction, sharpen or replace the tool as soon as abrasion is noted.

2. Inspecting the mounting screws

Regularly inspect all mounting screws and ensure that they are properly tightened. Should any of the screws be loose, retighten them immediately. Failure to do so could result in serious hazard.

3. Maintenance of the motor

The motor unit winding is the very "heart" of the power tool. Exercise due care to ensure the winding does not become damaged and/or wet with oil or water.

4. Inspection of terminals (tool and battery)

Check to make sure that swarf and dust have not collected on the terminals.

On occasion check prior, during and after operation.

CAUTION

Remove any swarf or dust which may have collected on the terminals.

Failure to do so may result in malfunction.

5. Cleaning on the outside

When the power tool is stained, wipe with a soft dry cloth or a cloth moistened with soapy water. Do not use chloric solvents, gasoline or paint thinner, for they melt plastics.

6. Storage

Store the power tool and battery in a place in which the temperature is less than 40°C and out of reach of children.

NOTE

Storing lithium-ion batteries.

Make sure the lithium-ion batteries have been fully charged before storing them.

Prolonged storage (3 months or more) of batteries with a low charge may result in performance deterioration, significantly reducing battery usage time or rendering the batteries incapable of holding a charge.

However, significantly reduced battery usage time may be recovered by repeatedly charging and using the batteries two to five times.

If the battery usage time is extremely short despite repeated charging and use, consider the batteries dead and purchase new batteries.

CAUTION











In the operation and maintenance of power tools, the safety regulations and standards prescribed in each country must be observed.





Important notice on the batteries for the HiKOKI cordless power tools

Please always use one of our designated genuine batteries. We cannot guarantee the safety and performance of our cordless power tool when used with batteries other than these designated by us, or when the battery is disassembled and modified (such as disassembly and replacement of cells or other internal parts).

NOTE

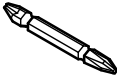
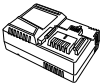
Due to HiKOKI's continuing program of research and development, the specifications herein are subject to change without prior notice.

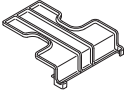
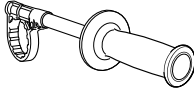
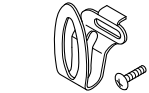
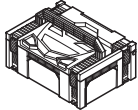
		DS18DC	DV18DC	DS36DC	DV36DC
	V	V	18	36	
n ₀	Ls	/min	0–500	0–550	
	Hs	/min	0–2000	0–2200	
Bpm	Ls	/min	—	0–7500	—
	Hs	/min	—	0–30000	—
		mm	—	20	—
		mm	102	118	
		mm	16	20	
	mm	6			
	mm	12	16		
	mm	1.5–13			
	kg	2.8			

	DS36DC, DV36DC	DS18DC, DS36DC, DV18DC, DV36DC
	(2XCP)	(NN)
	1	1
 UC18YSL3	1	—
 BSL36A18	2	—
	1	—
	1	1
	1	1
	1	—
	1	—

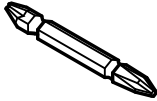

983006

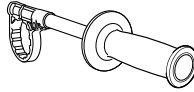

DS18DC, DV18DC: 379270
DS36DC, DV36DC: 379271



379397



310331



379343

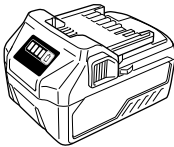

BSL36..18

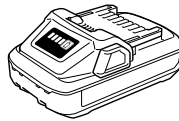

BSL18..

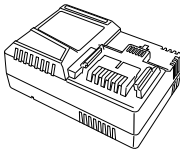

UC18YSL3 (14,4V-18V)

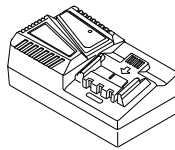

UC18YFSL (14,4V-18V)

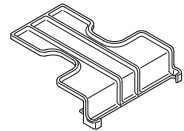

329897

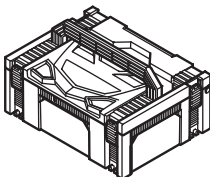

336471

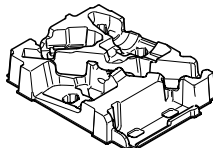

379127



Light Gold: 377857
Titanium Silver: 377858
Sky Blue: 377859
Violet: 377860
Signal Red: 377861

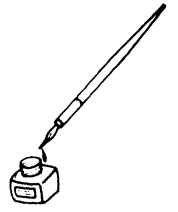

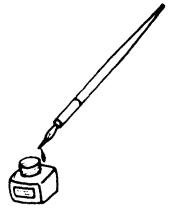

Koki Holdings Co., Ltd.

Shinagawa Intercity Tower A, 15-1, Konan 2-chome,
Minato-ku, Tokyo, Japan